

# X-ray Image Logger Safety Lights

## Introduction

This document is intended as a guide for an ET to wire the safety lights for the x-ray system. The light in question is a tri-colored light mounted on the top of the lead shielded x-ray box.

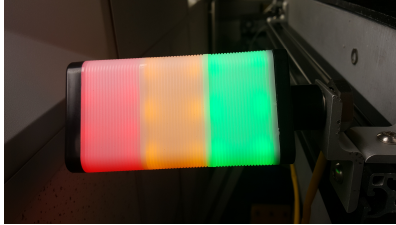

## Green light

**Purpose:** The green light is to indicate that the 5 safety switches are active and the track is in a safe and ready state.

**Plan:** To sense the state of the X-ray **TTL 15V** on the source, without affecting or changing the state of the X-Ray Source **TTL 15V Pin**.

**How:** The source needs to be programmed via the front panel to [\[MU1\]](#) confirm the state of the X-Ray pin before producing X-rays. We have no less than 5 switches in series on this line, all 5 switches needs to be in the closed and safe state for the source to activate.

1. Port side door switch

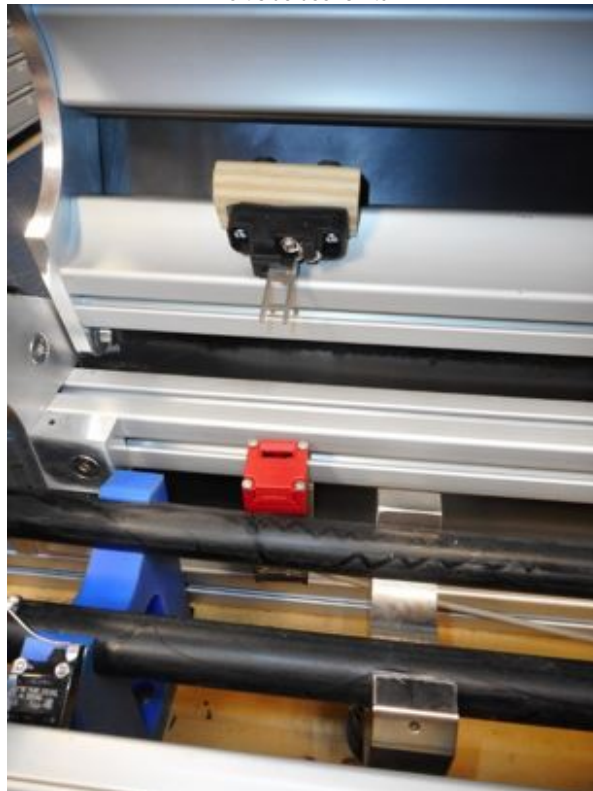

2. Area monitor high alarm switch



3. Latch switch on the lead box (inside the panel)



4. Starboard side switch



5. Emergency switch

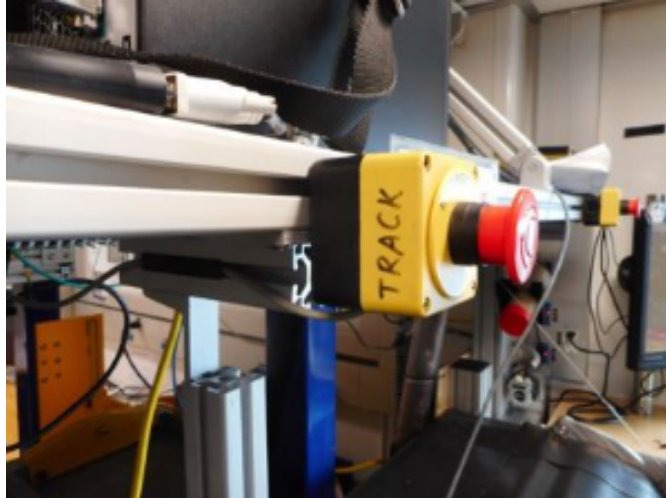

When all 5 switches are in the closed position the 15V TTL signal is pulled to ground, this indicates a safe to operate state to the source and X-rays could be generated. The challenge is to sense the state of the 15V TTL without changing or influencing it. The TTL level also needs to be sensed between the TTL Pin and the closest switch to the TTL Pin. The solution is to sense the TTL level with a 4049 IC. The IC uses 6uA from the circuit. The output of the IC is then pushed through an opto coupler to activate a relay and 24V is provided for the Green light.

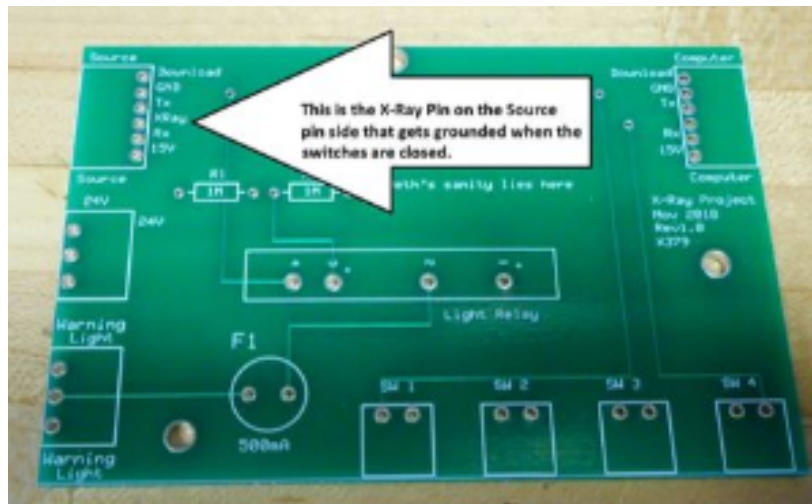

## **Yellow light**

**Purpose:** The yellow light is used to indicate that X-ray source is powered but no X-rays are being generated.

**Plan:** To sense the 15V supply line from the source. This is not the 15V TTL Pin. The source has a 15V supply line with 90mA available.

**How:** By using the 15V supply to activate a relay when the source is powered up.

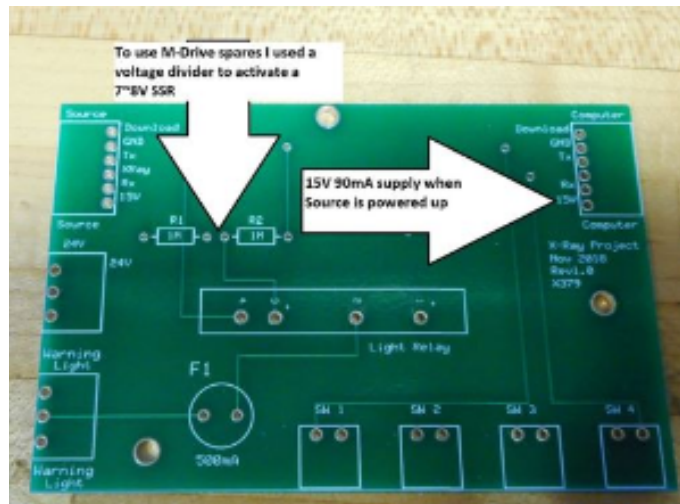

## Red light

**Purpose:** The red light is used to indicate when X-rays are being generated.

**Plan:** The only visual indication that the source is generating x-rays is a red flashing LED on the front panel of the source itself. This light is not visible when the source is properly shielded. We need to bring that indication out of the lead box using fiber optic cable.

**How:** We have plastic fiber optic wire that can we can use to detect the LED light inside the box. The fiber cable is used to change the value of a Light Dependent Resistor (LDR).

Below you can see the fiber cable and the LDR connection. The connection is achieved by simply inserting the fiber into a sleeve of "Heat shrink".

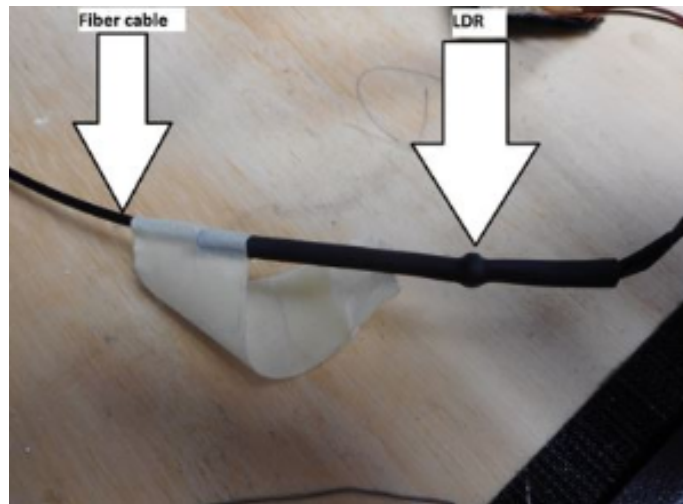

A 4mm hole was tapped into a piece of Plexiglas and glued with RTV to the CP120B source front panel.

Below you can see the Plexiglas with the fiber cable attached to the source as indicated by the white arrow.

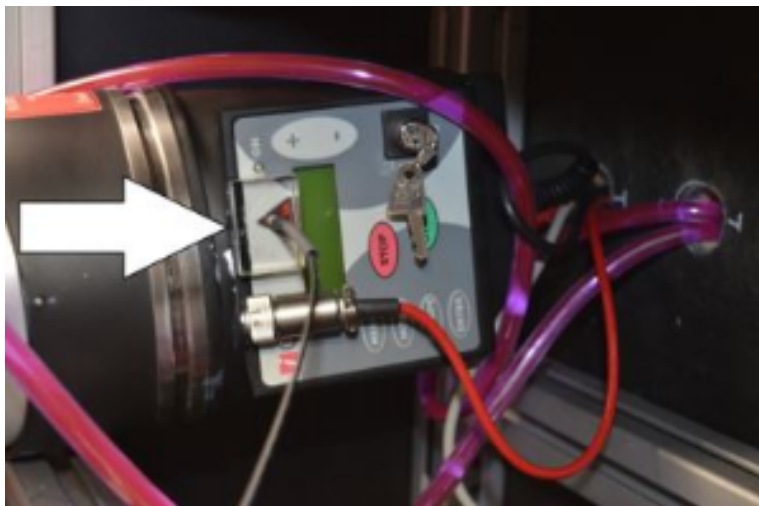

With the hole positioned over the LED indicator, the fiber cable can propagate the light sufficiently to change the value of a Light Dependent Resistor (LDR). When the LED on the source begins to flash, the LDR value changes. Using an LDR in a series/parallel circuit we could change the gate voltage on an IRF840 chip and thus switch it on and off.

In the image below shows the 6 Pin opto coupler, CNY17-4, the 16 Pin 4049 and the 24Vdc relay. There are 6 circuits on the 4049, you need to use pull down resistors on all the inputs to keep the IC stable.

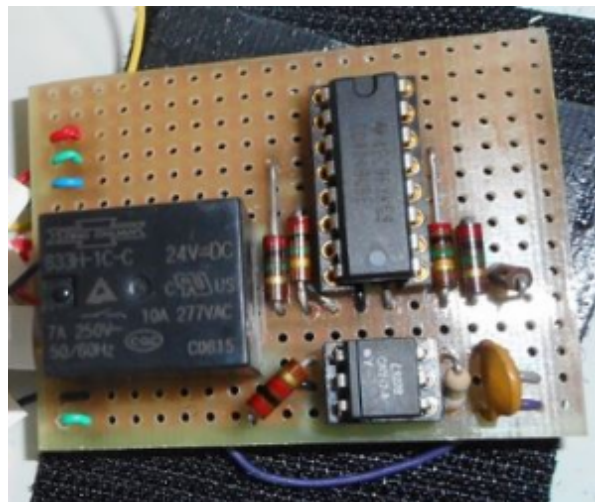

In the photograph below, you can see the IRF840 and the series/parallel resistor circuit to drive the gate pin. When the gate voltage is above 4.5-6 volts, the driver is active and the relay is switched. The red light should be on when the relay is switched.

