

APPLIED PHYSICS SYSTEMS

MODEL 520/520A FLUXGATE MAGNETOMETER

OPERATING MANUAL AND TECHNICAL REFERENCE

January, 2003

1245 Space Park Way
Mountain View, CA 94043 USA
650-965-0500 ♦ Fax 650-965-0404
E-mail aps@appliedphysics.com
Web <http://www.appliedphysics.com>

TABLE OF CONTENTS

I.	Introduction	
1.1	Description of Equipment	1
1.2	Front and Rear Panel Descriptions.....	2
1.3	Specifications	4
II.	Operating Instructions	
2.1	Unpacking and Initial Setup	7
2.2	General Performance Check.....	7
2.2.1	Zero Check	8
2.2.2	Zero Adjustment.....	8
2.2.3	Full Scale Amplitude Check.....	9
2.2.3.1	Earth's Field Test.....	9
2.2.3.2	Precision Coil Calibration	11
2.2.4	Noise Check	11
2.2.5	Orthogonality Check	11
2.3	Discussion of Magnetic Units	11
2.4	Degaussing of Probe.....	14
2.5	Sensor Placement in Probe	14
III.	Theory of Operation	
3.1	Block Diagram of the Probe	16
3.2	Block Diagram of the Readout Electronics	18

FIGURES

1a	Front Panel of the 520 Console	5
1b	Rear Panel of the 520/520A Console	5
1c	Front Panel of the 520A Console	6
2a	Earth's Magnetic Field Flux Lines	10
2	Variation of Total intensity of Magnetic Field over the Earth's Surface	10
3	Noise Spectrum Plot	12
4	Sensor Placement in 3 Axis Probe	15
5	Block Diagram of 520 Probe Single Axis Components	17
6	Block Diagram of 520 Readout Electronics	19

TABLE

1.	Conversion Table for Magnetic Units	13
----	---	----

I. INTRODUCTION

1.1 DESCRIPTION OF EQUIPMENT

Congratulations on your purchase of the Applied Physics Systems Model 520 Fluxgate Magnetometer! This instrument is a versatile one that enables measurement of magnetic fields over the very wide range of 5×10^{-7} Oe up to 1.0 Oe. The field is measured simultaneously along three orthogonal directions and is displayed on the front panel $3\frac{1}{2}$ digit liquid crystal displays. The full-scale reading can be changed in four steps from 1000 mOe to 1 mOe. On the 1 mOe scale, the least significant digit corresponds to a field change of 10^{-6} Oe. The three axes outputs can also be simultaneously monitored by an oscilloscope or a strip chart recorder at provided BNC connectors.

The 520 Fluxgate System can be employed to measure time varying as well as static fields. The system frequency response is flat from dc to 250 Hz, enabling measurements of power line generated fields, biologically related generated fields and other small, time varying fields.

The 520 Fluxgate System consists of a magnetic field measuring probe connected by a 15 foot interconnect cable to a power supply and electronic readout console. The small probe size permits magnetic measurements to be made in restricted spaces.

The 520A model system possesses all of the features of the model 520, but in addition includes precision offset capability on all three axes. This offset capability allows static fields up to 1 Oe to be nulled out by adjusting the front panel potentiometers. When the static field is nulled out, the sensitivity can be increased to facilitate monitoring small field changes in the presence of the large static field.

Typical applications for the 520 Fluxgate Systems include:

Measurement of magnetic fields inside steel and mu metal enclosures

Measurement (and zeroing) of the magnetic field trapped in superconducting shields including the Superconducting Rock Magnetometer

Study of the Geomagnetic field

Measurement of magnetic properties of materials

Measurement of power line generated magnetic fields

The 520 Fluxgate Magnetometer System has many useful features, including:

Simultaneous measurement of magnetic fields along three orthogonal axes

Low noise level of 5×10^{-7} Oe rms/Hz

Small three axis probe (1"Wx1"Hx $3\frac{1}{2}$ "L) allowing use in restricted spaces

3 simultaneous LCD displays with a resolution of 10^{-6} Oe (0.1 gamma)

4 selectable full-scale ranges: 1000 mOe, 100 mOe, 10 mOe and 1 mOe

Low drift--less than 10^{-5} Oe/°C

1.2 FRONT AND REAR PANEL DESCRIPTIONS

Front Panel of the 520 Model (see Fig. 1a)

X, Y and Z liquid Crystal Displays: three 3½ digit displays indicate the level of the magnetic field (in milliOersteds) measured by the probe. The magnetic field for each axis is displayed simultaneously.

Power: The power switch controls the power to the instrument. The red indicator light is on when the power is on.

Range: the range switch has 4 positions: 1000 mOe, 100 mOe, 10 mOe, and 1 mOe. This switch is positioned depending upon the level of magnetic field to be measured. The 1000 mOe range is used to display fields up to 1300 mOe. The 100, 10 and 1 mOe ranges allow field measurements up to 130, 13, and 1.3 mOe, respectively, before saturation.

Output switch: this switch is used to select the axis (X,Y or Z) which is connected to the front panel output BNC connector. This output can be connected to an oscilloscope, strip chart recorder or spectrum analyzer for analysis. Output resistance of the signal is 1 KΩ. Output full-scale voltage is ±10 volts for ±1000 mOe, ±100 mOe, ±10 mOe and ±1 mOe, depending upon the range selected.

Zeroes: the three front panel zero adjustment screws control three fine zero adjustment potentiometers. They allow the display and output signals to be adjusted to zero when the magnetic field at the probe is zero. Section 2.2.2 describes the method of adjusting them.

Probe connection: the APS550 3 Axis Fluxgate Probe connects to the console at this connector using the supplied multiconductor cable.

Additional Front Panel Features of the 520A System (see Fig. 1C)

Offset switch and indicator: this switch enables precision offset capability on all 3 axes up to 1 Oe.

Course and fine controls: these potentiometers enable independent coarse and fine adjustment of the offset on each axis.

Rear Panel of the 520 and APS 520A Models (see Fig. 1b)

Output connectors: a BNC connector is provided for each axis to permit simultaneous monitoring of the magnetic field signals measured by the system.

Fuse: wiring of the console is protected by an easily replaceable 0.8 Ampere fuse.

Power connection: power is connected to the console using the supplied power cord.

Power line voltage selections: some models of the 520 and 520A systems are equipped with dual transformer windings that allow operations on either 110V or 220V. This option is indicated by

the presence of a screwdriver adjustable voltage selector switch on the rear panel of the instrument. This switch should be adjusted to match the supplied voltage.

CAUTION: Severe damage to the instrument may result if the input power and voltage selector switch do not match!

(Optional)

I. Power input $\pm 18V$

Bendix connector pin	Function	Wire color
A	-18V	Green
B	Ground	Black
C	+18V	Red

II. Temperature

Bendix connector pin	Function	Wire color
A	Ground	Black
B	Probe thermometer	White
C	Not used	
D	Console thermometer	Red

1.3 SPECIFICATIONS:

Noise level (see Fig. 3)	3×10^{-7} Oe rms/Hz @ 5 Hz	
Frequency response	flat from dc to 250 Hz	
Linearity over ± 1 Oe	<0.1%	
Drift in zero with zero temperature	< 10^{-5} Oe/ $^{\circ}$ C	
Drift in full scale output with temperature	<0.01%/ $^{\circ}$ C	
Sensitivity	Full scale range	Sensitivity at output BNCs
	1000 mOe	10 V/Oe
	100 mOe	100 V/Oe
	10 mOe	1 V/mOe
	1 mOe	10 V/mOe
Orthogonality between axes	$\pm 0.2^{\circ}$	
Orthogonality between axes and reference surface (probe housing)	$\pm 0.2^{\circ}$	
Offset capability selectable (model 520A only)		
Low range	0 to ± 1 mOe	
High range	0 to ± 1200 mOe	
Probe size (WxHxL)	1"x1"x3"	
Probe weight (shielded enclosure)	4 oz	
Power supply/readout console	520	520A
size (WxHxL)	8½"x4"x15"	8½"x6"x15"
weight	7 lbs.	9 lbs.
Cable	shielded 8-conductor 15' length	
Cable connectors	Bendix PT06 style	
AC power requirements	115V 0.5 Amp or 220V 0.25 Amp (See rear of instrument)	
Fuse	0.8A SB	

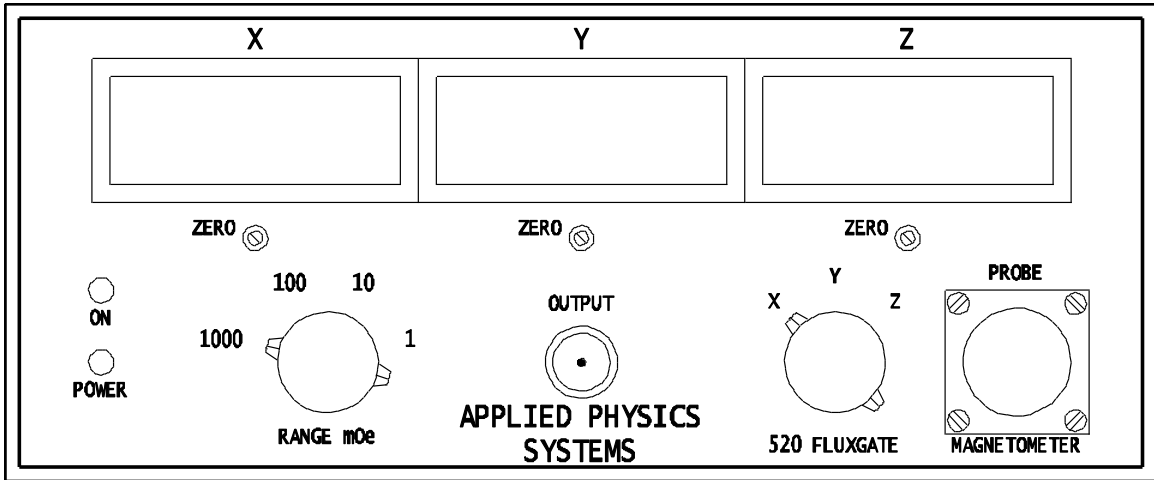

Fig. 1a Front Panel of 520 Console

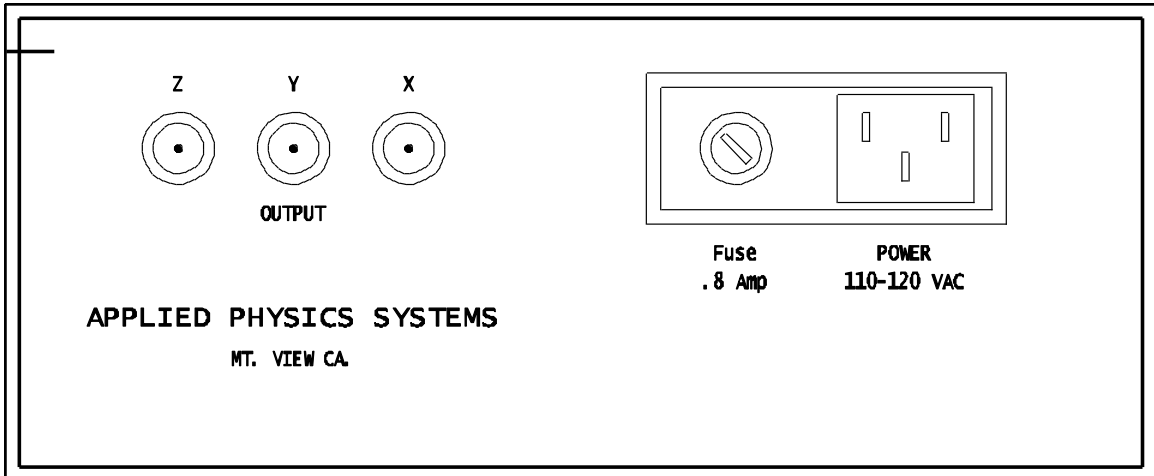

Fig. 1b Rear Panel of 520 Console

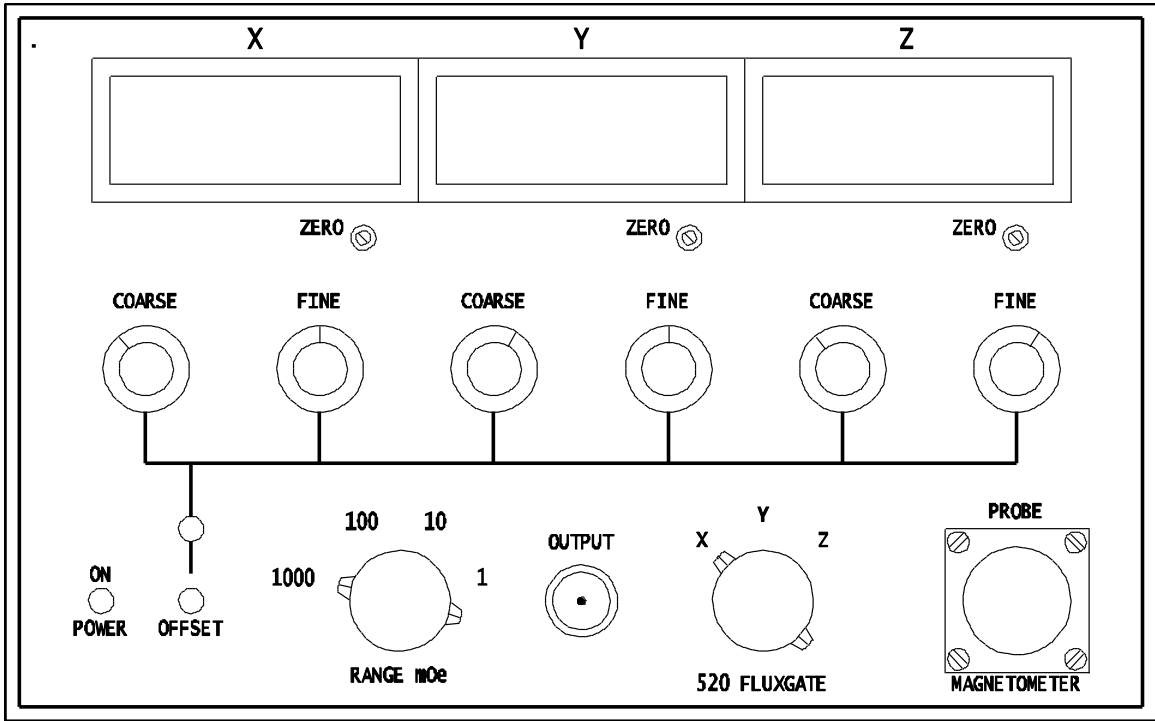

Fig. 1c Front Panel of 520A Console

II. OPERATING INSTRUCTIONS

2.1 UNPACKING AND INITIAL SETUP

Unpack the instrument; if you find any damage, report this to Applied Physics Systems and the carrier responsible for delivery.

The instrument consists of four parts:

1. 520 or 520A Fluxgate Magnetometer Readout Console
2. APS550 3 Axis Fluxgate Probe
3. 15 foot multiconductor interconnect cable
4. Power cable

Connect the Fluxgate Magnetometer Probe to the front of the Fluxgate magnetometer Readout Console using the multiconductor cable. This cable has bayonet connectors at each end, which lock into place when the outer shell is rotated clockwise after engaging the connector.

The 520 and 520A Models are factory configured for 115 VAC operation. Operation from 208-230 volt mains is possible with models that have been equipped with dual transformer windings, provided the voltage selector switch is configured for this higher voltage. This switch is located on the rear panel of the instrument near the power input plug. Use a small screwdriver to select the 210 volt option if this is desired.

After the input voltage range is selected, connect the provided power cable to the rear of the Fluxgate Magnetometer readout console and plug the other end into a power receptacle. If 210 volt operation is used, an appropriate plug will have to be used on the power cable to match the power receptacle.

After making these connections, the instrument may be turned on using the front panel power switch.

Note on reading the front panel display:

The liquid crystal displays do not use leading zero blanking. Hence if you are on the 1000 mOe scale and the display reads 0512, this means that the field is 512 mOe or 0.512 Oe. You should disregard leading zeroes whenever they appear on the display.

2.2 GENERAL PERFORMANCE CHECK

Turn the front panel RANGE selector switch to the 1000 mOe range. In this position, the instrument is able to measure magnetic fields up to ± 1300 mOe before saturation of the probe occurs. The three liquid crystal displays should display the local X, Y and Z magnetic field of the earth at the probe location. Move the probe around and the displays will change as the magnetic field along the probe X, Y and Z directions change.

2.2.1 ZERO CHECK

With the 1000 mOe range selected, place the 3 Axis Fluxgate Probe in a high permeability magnetic shield. All three axes of the display should read zero (assuming the field inside the shield is less than 1 mOe).

NOTE: If the displays do not read zero, the probe may need to be demagnetized (See section 2.4).

While the probe is in the low field region, increase the sensitivity by changing the range switch successively to 100 mOe, 10 mOe and finally 1 mOe. On the last highest sensitivity scale, the least count on the display corresponds to 0.001 mOe or 0.1 gamma (1 mOe=100 gamma). In all probability, the three displays will not be zero on the highest several ranges because: 1. It is very difficult to obtain a magnetic field environment less than 0.1 mOe in a high permeability shield system and 2. The fluxgate magnetometer may shift a small amount from time to time due mainly to ambient temperature changes.

In a low field environment, it is usually required that the probe be rotated through 180° to determine the true magnetic field amplitude down to the nearest 0.1 mOe in any given direction. To do this, first align one of the fluxgate magnetic axes along the specific direction of interest and record the value of the magnetic field readout. Next, rotate the probe 180° along an axis perpendicular to the axis being examined and again record the magnetic readout value. The true field can be obtained by adding the two readout values together and dividing by 2.

2.2.2 ZERO ADJUSTMENT

To enable adjustment of the magnetometer output voltage and display to zero for zero magnetic field, we have provided both a fine and coarse zero adjustment capability. The fine adjust is accomplished with a front panel mounted 10-turn potentiometer for each axis (see Fig 1a). The coarse zero adjustment is made with three 10-turn potentiometers mounted on the main printed circuit board.

To adjust the coarse zero, it will be necessary to remove the top cover of the 520 console. This is done by removing the 4 screws at the top corners and sliding the cover toward the rear of the console. The three potentiometers in question are close to the front of the console (nearest to the output meters) and are marked "X," "Y," and "Z."

To adjust the coarse zero, select the 1000 mOe range and place the probe in a low field region ($B < 1\text{mOe}$); adjust the coarse zero potentiometers to obtain zero output on the meters for each axis. Next select the 100 mOe range and repeat the coarse zero adjustment. On this range, the last digit represents 0.1 mOe, which is well within the range of the fine zero adjustment potentiometers ($\pm 2\text{ mOe}$).

To adjust the fine zeroes, keep the probe in the low field region and proceed by selecting first the 10 mOe range and then the 1 mOe range and adjusting the front panel fine zero potentiometers to obtain zero outputs in the X, Y, and Z output meters. Since in all likelihood the field in the low field region will not be exactly zero, it will be necessary to rotate the probe by 180° to obtain true zeros in the range of fields less than 0.1 mOe (10 gamma). To do this, place the probe in a stable position in the low field region and record the value of the X magnetic readout. Now rotate the probe 180° around the Y axis direction and again record the X magnetic field readout. Find the difference between the two recorded readings. Divide this value by 2 to find the amplitude of the magnetic field in the direction chosen. Without moving the probe from the 180° rotated position, adjust the fine zero potentiometer so that the X axis display reads the previously computed true

field amplitude. This procedure should be repeated for the Y axis by rotating about the X direction and for the Z axis by rotating about the X direction.

CAUTION: The fine zero adjust is performed at the factory before shipment, and hence, the instrument zeroes should be within 0.1 mOe (10 gamma) of true zero when you receive it. The above procedure need only be carried out if you require true zero indication better than 0.1 mOe.

2.2.3 FULL SCALE AMPLITUDE CHECK

There are two methods of checking the scale factor of the instrument:

1. Earth's field test
2. Precision Helmholtz coil test

Each method is described below.

2.2.3.1 EARTH'S FIELD TEST

This test is only a qualitative test but should verify scale factor to within $\pm 10\%$. First refer to Fig. 2 to determine the amplitude of the earth's magnetic field at your location. For example, in Palo Alto, California, this is

$$H_e = 0.51 \text{ Oe}$$

Note that in most northerly locations, the earth's magnetic field points generally north and is inclined into the ground at an angle of approximately 60° .

Next, point the magnetometer probe X axis down into the earth's field. To do this, the probe will be positioned downward at about 60° and oriented so as to point generally north. Note the reading on the X axis display. It should be recording near the value of the field obtained from the chart in Fig. 2. While pointing into the earth's field, gently rotate the probe 10-15 degrees around the Y axis and the Z axis to find the maximum reading. The exact position is not too critical since the response to both rotations is proportional to the cosine around zero degrees. When the final maximum reading is obtained, this should correspond to the value from Fig. 2 to within about $\pm 10\%$.

Check the Y and Z axis calibrations in a similar way by pointing these axes in turn into the earth's magnetic field and comparing their response to the known field value.

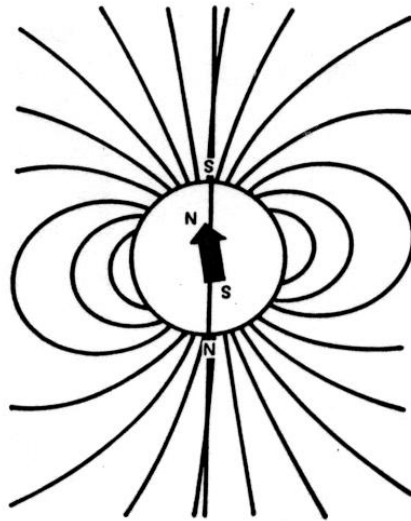

Fig. 2a Earth's Magnetic Field Flux Lines

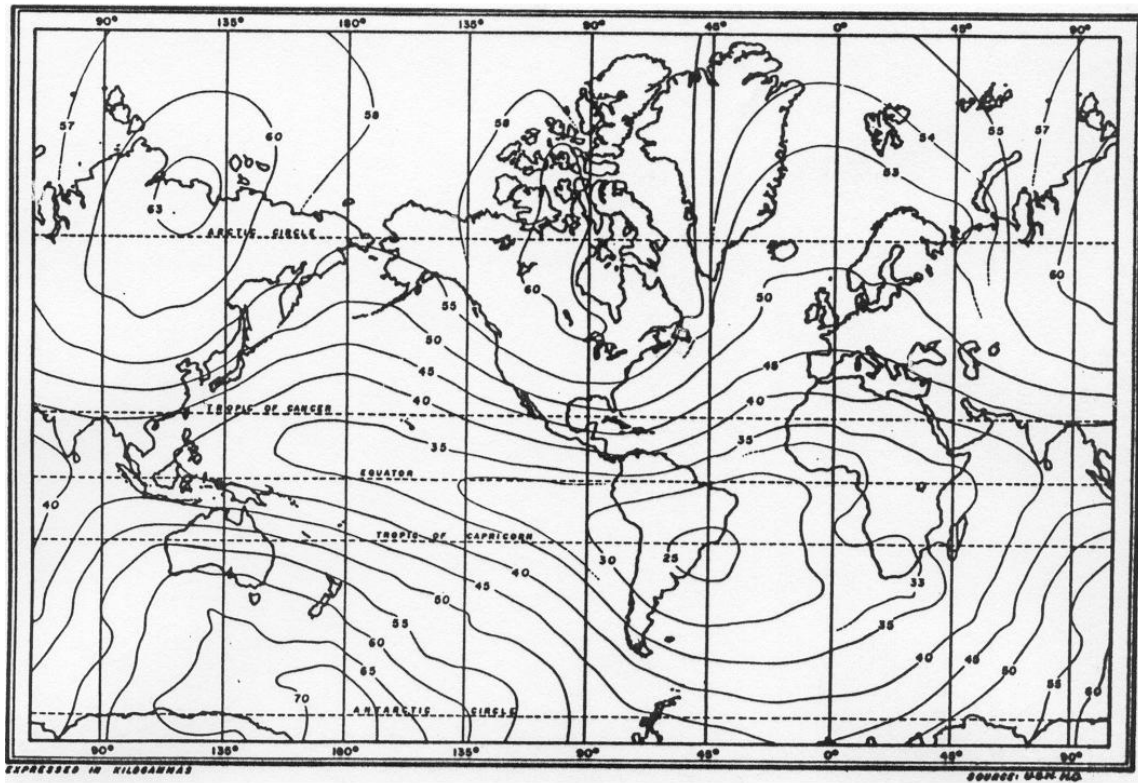

Fig. 2 Variation of Total Intensity of Magnetic Field Over the Earth's Surface

2.2.3.2 PRECISION COIL CALIBRATION

If you have access to a precision coil (for example, a large Helmholtz coil), you can use it to measure the output scale factor of the fluxgate magnetometer. We use this method of calibration to adjust the scale factor at the factory.

To use this procedure, place the fluxgate probe so that a precise field of 1000 mOe can be applied to it. Generally, a low frequency square wave excitation is most desirable (period ~10 seconds). Select the 1000 mOe range and (using a DC current) apply a DC magnetic field to the probe to obtain a zero output display. Now apply the low frequency square wave excitation of amplitude ± 1000 mOe to the probe and verify that the output reads ± 1000 mOe. Check the full-scale output on the 100, 10 and 1 mOe ranges using corresponding lower precision excitations. Note that full-scale calibration is done at the factory to within 0.1% and that this adjustment should not generally have to be made when you receive your instrument.

2.2.4 NOISE CHECK

There are several ways to check the system noise level. In all cases, knowledge of the measurement bandwidth is required. The easiest method is to use a spectrum analyzer, especially one that samples the output and computes the Fast Fourier Transform. The system noise level is generally measured in a shielded environment (for example inside a two or more layer mu metal shield).

Connect the spectrum analyzer to the output BNC connector on the front panel of the magnetometer console, and rotate the axis selector knob to select the desired axis. Increase the sensitivity of the magnetometer by selecting the 1 mOe range. Obtain a noise spectrum plot and compare it with Fig. 3. Repeat the procedure for all three axes. Note that if your spectrum analyzer has enough gain, the spectral plots can be made using any of the 4 ranges. The instrument noise level when expressed in mOe is the same for all ranges.

As an alternative, a bandpass amplifier and true RMS meter can be used at the output to measure the system noise level.

2.2.5 ORTHOGONALITY CHECK

The orthogonality of the three measurement axes as well as their orientation with respect to the outer probe housing are factory adjusted to better than 0.2° . This adjustment is made using a precision Hemholtz Coil and readjustment is generally not required thereafter if the probe and readout console are not changed.

2.3 DISCUSSION OF MAGNETIC UNITS

The 520 Fluxgate Magnetometer is calibrated to read directly in milliOersteds (mOe) (1000 mOe = 1 Oe). In the cgs system this is the unit for the H field. The unit for the B field is the Gauss (G). In the cgs system, the size of the H and B field units are the same, i.e. a one Oe field in a vacuum is equivalent to a one G field. The output of the 520 is hence essentially also calibrated in milligauss (mG). In the MKS system, the measurement unit of B is the Tesla (T) and the unit of H is the ampere turn per meter (AT/M). These units do not have the same numeral size. Another hybrid unit, the gamma, is sometimes used. Conversions between the various units can be made using Table 1.

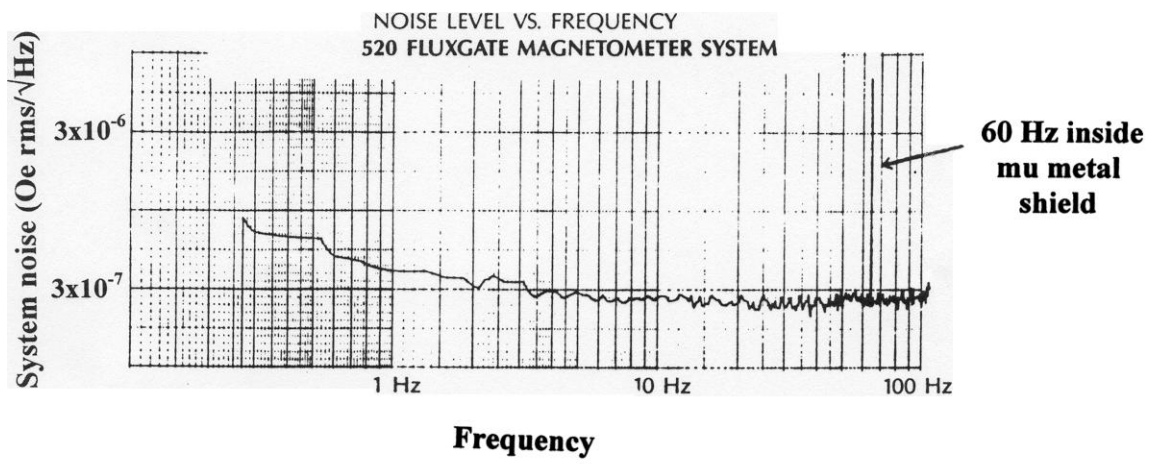

Fig. 3 Noise Spectrum

Conversion Table for Magnetic Units

Magnetic Flux

	<u>Maxwell</u>	<u>Kiloline</u>	<u>Weber</u>
1 maxwell (1 line or 1 emu)	1	0.001	10^{-8}
1 kiloline	1000	1	10^{-5}
1 weber	10^8	10^5	1

1 esu = 299.8 webers
 1 maxwell = 1 gauss-cm²

Magnetic Induction B

	<u>Gauss</u>	<u>Kiloline/in.²</u>	Tesla (Weber/Milli-meter ²)	<u>Gauss</u>	<u>Gamma</u>
1 gauss (line/cm ²)	1	6.452×10^{-3}	10^{-4}	1000	10^5
1 kiloline/in. ²	155.0	1	1.55×10^{-2}	1.55×10^5	1.55×10^7
1 tesla (web/m ²)	10^4	64.52	1	10^9	
1 milligauss	0.001	6.452×10^{-6}	10^{-7}	1	100
1 gamma	10^{-5}	6.452×10^{-8}	10^{-9}	0.01	1

1 esu = 2.998×10^6 webers/meter²

Magnetomotive Force

	<u>Abamp-turn</u>	<u>Amp-turn</u>		<u>Gilbert</u>
1 abampere-turn	1	10		12.57
1 ampere-turn	0.1	1		1.257
1 gilbert	7.958×10^{-2}	0.7958	1	

1 pragilbert = 4π amp-turn
 1 esu = 2.655×10^{-11} amp-turn

Magnetic Field Strength H

	<u>Abamp-turn/cm</u>	<u>Amp-turn/cm</u>	<u>Amp-turn/in.</u>	<u>Amp-turn/meter</u>	<u>Oersted</u>
abampere-turn/cm	1	10	25.40	1000	12.57
ampere-turn/cm	0.1	1	2.540	100	1.257
ampere-turn/in	3.937×10^{-2}	0.3937	1	39.37	0.4947
ampere-turn/meter	0.001	0.01	2.540×10^{-2}	1	1.257×10^{-2}
oersted	7.958×10^{-2}	0.7958	2.021	79.58	1

1 oersted = 1 gilbert
 1 esu = 2.655×10^{-9} amp-turn/meter
 1 praersted = 4π amp-turn/meter

2.4 DEGAUSSING OF PROBE

The three-axis fluxgate probe is largely constructed using nonmagnetic components. A few subcomponents are weakly magnetic, however, and if the probe is subjected to high ambient fields (>10 Oe), these components can be permed up. This will result in a zero shift in the output (when the probe is put into a zero magnetic field environment, the displays will not read zero). The higher the perming that occurs, the greater the zero shift. To eliminate this problem, the probe should be demagnetized (degaussed) in a low field environment.

To demagnetize the probe, it should be subjected to a large amplitude AC magnetic field (>50 Oe). We generally use a magnetic tape demagnetizer to do this; these devices are used to demagnetize recording tape and are available at Radio Shack and similar stores.

Place the probe and demagnetizer in a mu metal shield and turn on the demagnetizer. Move the demagnetizer slowly around all sides of the probe. Finally, while keeping the demagnetizer on, slowly move it away from the probe to smoothly decrease the AC field at the probe. When the demagnetizer is several feet away, it may be turned off.

If necessary, adjust the fine zero potentiometer (see section 2.2.2) to obtain a zero output voltage for zero field.

2.5 SENSOR PLACEMENT IN PROBE

The placement of each of the three sensors in the probe is shown in Fig. 4. Each ring core element shown in this figure is approximately 0.6" in diameter and 0.1" thick and generally senses the field over this volume.

FIG. 4
SENSOR PLACEMENT
MODEL 520 SYSTEM PROBE

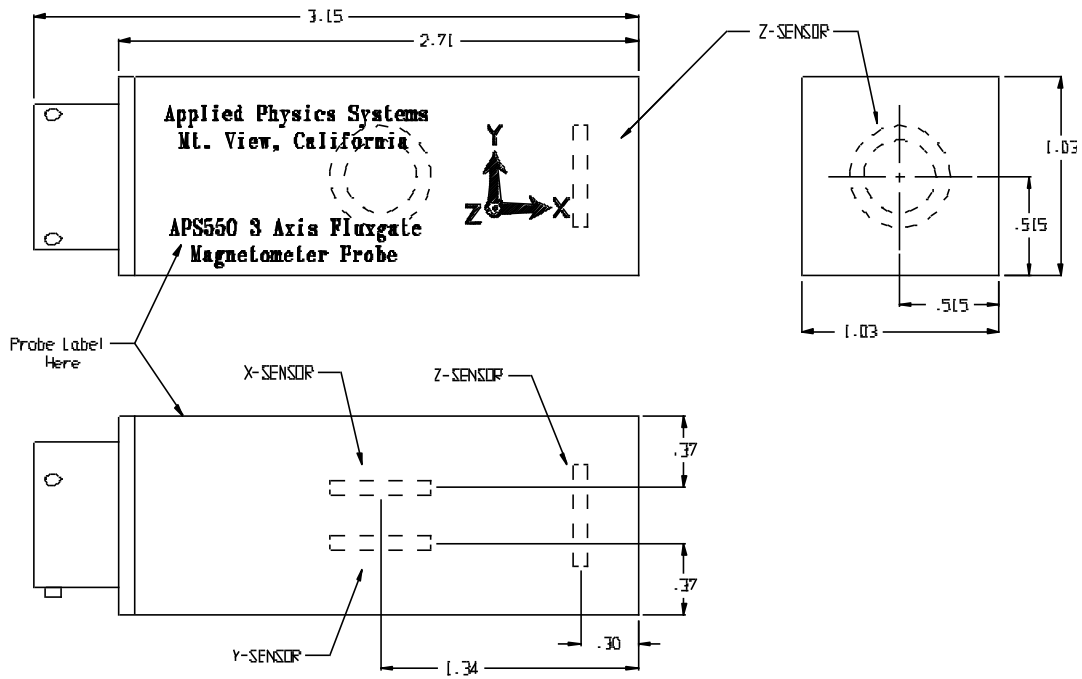

*All Dimensions Shown In Inches.

III. THEORY OF OPERATION

3.1 BLOCK DIAGRAM OF THE PROBE

A block diagram showing the component parts of a single fluxgate axis is shown in Fig. 5. The magnetic sensing element is composed of a toroidal ring composed of very high permeability material ("supermalloy"). The ring is wrapped with a toroidal excitation coil, L_t , which is used to periodically saturate the core at a frequency of about 25 KHz. The core is quite easy to saturate because of its high permeability; the core saturates with the application of about a 0.05 Oe field. The toroid is also wrapped with a pickup coil, L_p , which extends around the entire toroid. This pickup coil is used to sense the presence of an external field.

The system works in the following manner: Imagine that an external field is present and its orientation is parallel with the axis of the diameter wound pickup coil. Since the toroid represents a low reluctance path, the external field bends to go through both legs of the toroid so long as it is not saturated. Once saturated, the toroid reluctance is no longer low and the field does not bend to go through it. Now if we periodically saturate the toroid with a toroidal winding, we will periodically allow an external field to be "sucked" into and then "expelled" from the toroid. We have in effect created a parametric up converter wherein a low frequency external magnetic field variation is up converted to sidebands around the second harmonic of the pump (toroid drive) frequency.

The magnetic field moving in and out of the toroid creates a voltage in the diameter wound pickup coil. Since the field collapses and reenters the toroid in an identical manner when the toroidal drive coil saturates in either the plus or minus direction, we have a pickup voltage proportional to the external field amplitude but at the second harmonic of the pump frequency.

The block diagram of the toroid drive circuit shows the oscillator driving several divide-by-two circuits. The first divide-by-two is required to eliminate even harmonics from the drive oscillator. The second divide-by-two is necessary to create a drive frequency that is one-half the frequency of the second harmonic reference voltage necessary for synchronous detection of the pick up coil voltage.

The synchronous detection circuitry is essentially a switch which is turned on and off at the second harmonic frequency. This in effect multiplies a second harmonic square wave with the incoming pickup coil signal. Such multiplication produces both a sum frequency component (fourth harmonic of the drive) and a difference frequency component (low frequency ~ dc) at the mixer output. The original signal is represented by the difference component. We use the integrator to filter out the fourth harmonic signal.

To enhance the linearity of the system, the output of the integrator is fed back to the field pickup coil through a series resistor. This coil carries a low frequency or dc signal that nulls out any applied external magnetic field. In this situation, the ring core sensor essentially operates as a null detector.

The output of the integrator in Fig. 5 is fed to the Fluxgate Readout Console described in the next section.

FIG. 5
BLOCK DIAGRAM OF
FLUXGATE PROBE
 (One Axis Shown)

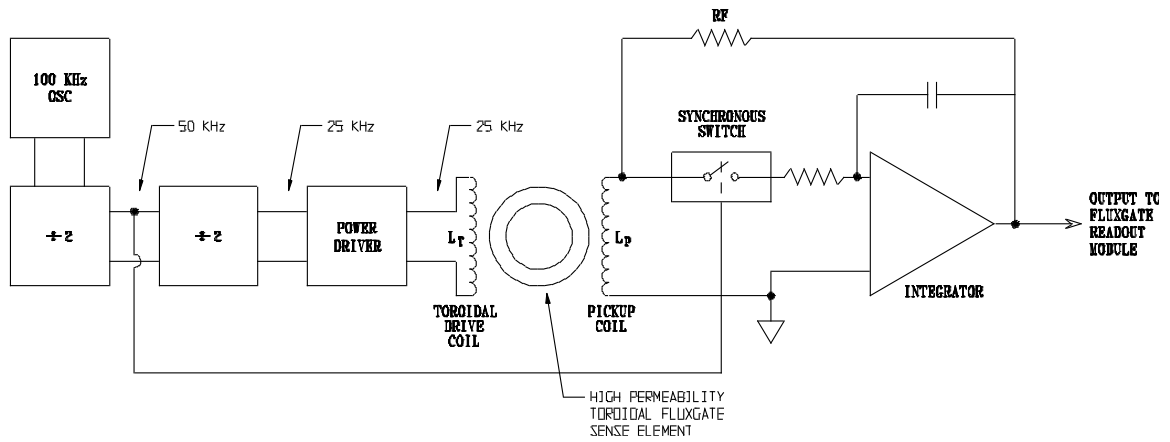

3.2 BLOCK DIAGRAM OF THE FLUXGATE READOUT CONSOLE

A block diagram of the Fluxgate Readout Console electronics is shown in Fig. 6. The output of the sensor signal processing electronics is first buffered by a unity gain amplifier. The output of the buffer is then summed with 4 signals:

1. Coarse null
2. Fine null
3. Y orthogonality adjust
4. Z orthogonality adjust

In 520A systems, a fifth signal, corresponding to the precision dc offset capability, is also summed at this point.

The orthogonality adjustments are required to enable the alignment of the three sensors with respect to the reference surface (outer case). We have assumed that we are describing the X fluxgate sensor in Fig 6, so that it is necessary to sum in a small amount of signal from the Y and Z sensors. This in effect allows us to electronically tilt the X sensor in the Y and Z directions until it is aligned along the X reference surface direction. This orthogonality adjustment must be accomplished at the factory by putting the fluxgate probe into a precision external coil and applying signals along known directions.

The summing circuit output is fed to a selectable gain block, the gain of which is controlled by the front panel Range switch. This gain block provides 1X, 10X, 100X and 1000X gain to expand the system sensitivity. Full-scale adjustment potentiometers are also included to enable the output to be calibrated on each range.

The selectable gain block feeds the front panel liquid crystal display, rear panel BNC output connectors, and an output select circuit. The output select circuit is controlled by a front panel select switch and feeds the front panel BNC connector.

Power for all circuits is provided by a power supply, which provides $\pm 15\text{VDC}$ and a $+5\text{VDC}$.

FIG. 6
 BLOCK DIAGRAM OF
 FLUXGATE MAGNETOMETER
 READOUT ELECTRONICS
 (One Axis Shown)

