

# NGR User Guide

- Introduction
- Theory of Operation
  - Hardware
  - Launching the IMS-SRM application
  - A Quick Introduction to the IMS Program Structure
- NGRL Startup & Shutdown Procedures
  - Shutdown Criteria
  - Partial Shutdown Procedure
  - Full Shutdown Procedure
  - Startup Procedure
- Initial Instrument Setup
  - NGR Instrument General Setup
- Motion Control Setup:
  - Motor & Track Options menu
  - Fixed Positions menu
  - Limit & Home Switches window (Figure 25)
  - Motion Profiles
- Background Measurement
- Calibration Procedures (REVIEW WITH PP TECHNICIANS)
- 1. Collimated Sources (REVIEW WITH PP TECHNICIANS)
- 2. Non-Collimated Sources (REVIEW WITH PP TECHNICIANS)
  - Tuning the NGRL Voltage Settings (this section may not be applicable for IMS version - confirm during next Exp.) (REVIEW WITH PP TECHNICIANS)
  - Calibration of NGRL Spectra for Analysis of 40K, 238U, and 232Th ("KUT") Concentrations
  - Time Calibration
- Sample Preparation and Analysis
  - Preparing Samples
  - Running Samples
- LIMS Integration
  - Data Upload Procedure
  - Data File Formats
  - Data Available in LORE
- Communication and Control Setup
- Credits
- Archived Versions

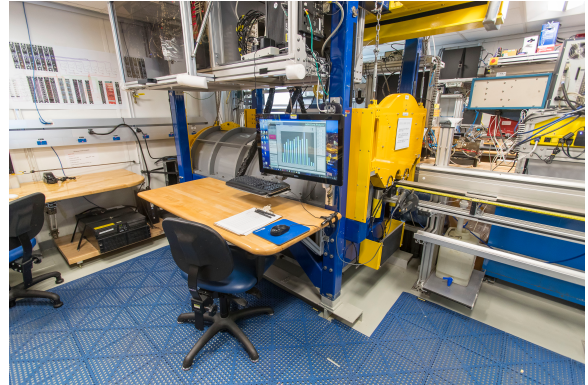

## Introduction

This guide describes standard operating procedures for the Natural Gamma Radiation Logger (NGRL), designed and built at the Texas A&M University IODP-JRSO facility in 2006-2008. The NGRL measures gamma ray emissions emitted from whole-round core sections, which arise primarily due to the decay of U, Th, and K isotopes. Minerals that fix K, U, and Th, such as clay minerals, are the principal source of natural gamma radiation.

Concentrations of uranium, thorium and potassium in geological materials provide insight into many important lithological characteristics and geologic processes. In marine sediment, they can aid in identifying clay compositions, depositional environments, and diagenetic processes. In hard rock, they can yield information about the alteration and heat production of rocks (Dunlea et al., 2013). A high-efficiency, low-background system for the measurement of natural gamma radioactivity in marine sediment and rock cores designed and built by the JRSO at Texas A&M University is used aboard the *JOIDES Resolution*.

Electromagnetic gamma rays are emitted spontaneously from an atomic nucleus during radioactive decay. Each nuclear isotope emits gamma rays of one or more specific energies. NGR data are reported in total counts per second, a quantity dependent on instrument and core volume, derived from the integration of all counts over the photon energy range between 0 and ~3.0 MeV. Total counts represents the combined contributions by K, U, and Th, matrix density resulting from Compton scattering, and matrix lithology resulting from photoelectric absorption. Data generated from this instrument are used to augment geologic interpretations.

## Theory of Operation

The NGR Logger consists of eight Sodium Iodide (Thallium) (NaI) detectors surrounded by both passive and active shielding. The measurement of natural radioactivity from core samples faces the challenge of overcoming background noise, which consists of environmental radioactivity and cosmic radiation. In order to protect measurements from environmental noise the NGR system includes several layers of lead, which act as a passive shield. However, lead shielding is not enough to eliminate enough of the incoming cosmic radiation to measure low-count cores. To reduce the cosmic background further the NGR has a layer of active shielding consisting of plastic scintillator detectors and nuclear electronics. There are five plastic scintillators on the top of chamber and an additional plastic scintillator inside each NGR door. For rejection of counts in NaI(Tl) detectors associated with cosmic rays, fast-slow coincidence logic was implemented. In the event of coincidence within a 400-500 ns window between signals from the fast outputs of NaI(Tl) detectors and any of the seven plastic scintillators, a VETO signal is generated on the gate input of the multichannel analyzer modules (MCAs) and further readout of such an event is rejected.

A core section measurement consists of two positions, counted for at least 5 min each for a total of 16 measurements per section. A typical ~150 cm whole-round core section is wiped dry and placed in a titanium boat on the loading end of the instrument, where a barcode scanner reads the section label and imports sample information from the database. The length of the section is input by the user. The boat stops at position #1, where the top of the boat is positioned 10cm past the edge of NaI detector #8 (starboard-most detector). After measuring at position #1 for a user-defined time period (not less than 5 minutes), the boat moves 10 cm outboard (port) and begins counting at position #2. When the run completes, the section returns to the starting position and can be unloaded.

NGR analysis results are expressed as spectra (counts vs keV energy) for each measurement offset and the raw spectra are saved in a zip folder in the database. The spectra are reduced by the NGRL software and produce total counts per second (cps), adjusted for energy threshold (>100 keV), edge corrections, and background radiation.

Energies below 100 keV (and into the X-ray portion of the spectrum) are not recorded, as the NGRL has not been designed to characterize the natural radioactivity below this level.

For more details, please see [Vasilyev et al. \(2011\)](#)

## Hardware

The NGRL system consists of five major units (*Figure 1*):

- Support Frame
- Main NGRL detector unit (NGR chamber)
- Electronics crate
- Core delivery system
- computer and APC uninterruptible power supply (UPS) battery system

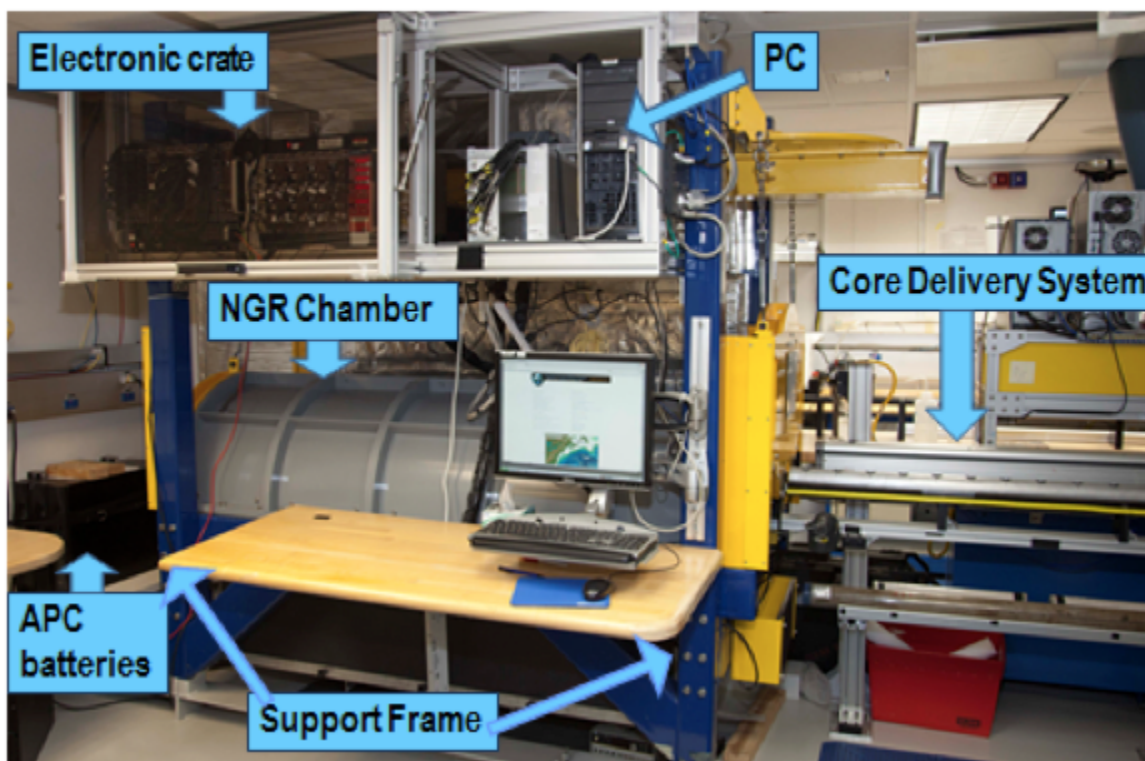

Figure 1. NGR logger system components.

## Support Frame

The support frame holds the NGRL components, including the heavy lead layers of the passive shield. It is constructed of steel that is welded to the support rails distributing the 5 tons of weight evenly on the deck, preventing it from shifting in heavy seas. A steel I-beam frame above the logger allows for transportation of heavy components during any assembly/disassembly activities or for opening the doors by using the chain hoist. Note: Both NGRL doors contain plastic detectors inside and two PMT units beneath each door. These are very fragile and care must be taken not to damage them while moving the doors! Currently on the ship the NGRL operates with door #1 fixed in the open position. Door #2 (back door) stays closed. Open door #2 to place an NGR standard over detector #8, as the standard will need to be positioned past the normal stop position.

## Main NGR Detector Unit

The main NGR detector unit consists of the following (Figure 2, Figure 3):

- Passive lead shielding
- 8 NaI scintillator detectors
- 7 plastic scintillator detectors
- 22 photomultiplier tubes (PMT)

## Passive Lead Shielding

The NaI detectors are covered by at least 8 cm of lead shielding. In addition, lead separators (~7 cm of low-background lead) are positioned between the NaI detectors. The innermost 4 cm of the lead shielding is low-background lead, while the outer 4 cm is composed of virgin lead. The inherent radioactivity of the virgin lead is such low energy that the inner 4 cm of low-background lead shields nearly 100% of it. The internal radioactive rates of the lead shields are:

- Low-background lead = ~3 Bq/kg
- Virgin lead = typically 50–200 Bq/kg

## NaI Scintillators

The NaI detectors are housed in stainless steel and hermetically sealed against atmospheric moisture. The sodium iodide crystals are extremely hygroscopic so if moisture intrudes the housing they can lose their optical properties. For this reason, it is vitally important that the detector housings be protected from corrosion. Each detector is a half-ring of 10 cm thick x 10 cm wide NaI; the shape is to maximize the efficiency of capturing gamma rays emitted from whole-round core sections. Each detector has its own photomultiplier tube (PMT).

The position of the NaI detectors is fixed and each detector center is precisely 20.00 cm from its neighboring detectors. In the IMS software, the detector positions are relative to the top of the titanium boat when it is at the home switch. Determined experimentally, these are as shown in Table 1, below. If these positions are not correct, the analysis will be applied to an improper position of the core section and (more importantly) the edge correction will be applied incorrectly. In the past, this led to results that were too high on the top of section and too low on the end of section, but the opposite case might occur.

Detector number	Position from top of boat
1 (port-most)	41.96 cm
2	61.96 cm
3	81.96 cm
4	101.96 cm
5	121.96 cm
6	141.96 cm
7	161.96 cm
8 (stbd-most)	181.96 cm

Table 1. NGR NaI detector positions

## Plastic Scintillators

In addition to passive lead shielding, the NGR employs plastic scintillators to suppress the high-energy gamma and muon components of cosmic radiation by producing a VETO signal when charged particles from cosmic radiation pass through the plastic scintillators:

- 5 shell-shaped plastic detectors cover the upper hemisphere around the NaI detectors
- 2 flat plastic shields placed inside the doors to cover the detectors from the ends

Each plastic detector has two PMTs to maximize light collection across a somewhat large detector surface. Each PMT senses approximately 80% of the detector.

## Photomultipliers

Signal processing from all PMTs is organized through standard NIM electronics modules. The photomultipliers are located beneath the detectors, 1 for each NaI detector and 2 on each door and shell-shaped plastic detector.

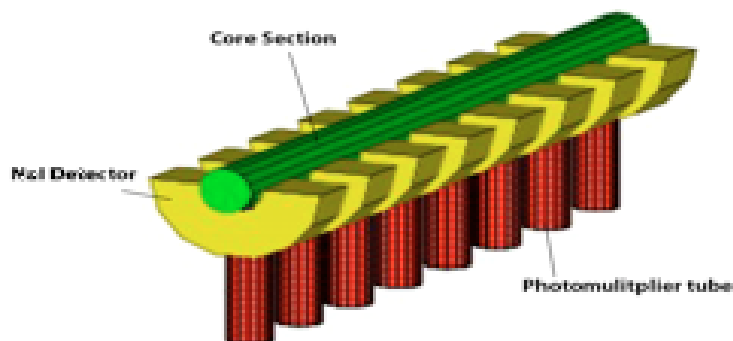

Figure 2. NGR detector system schematic.

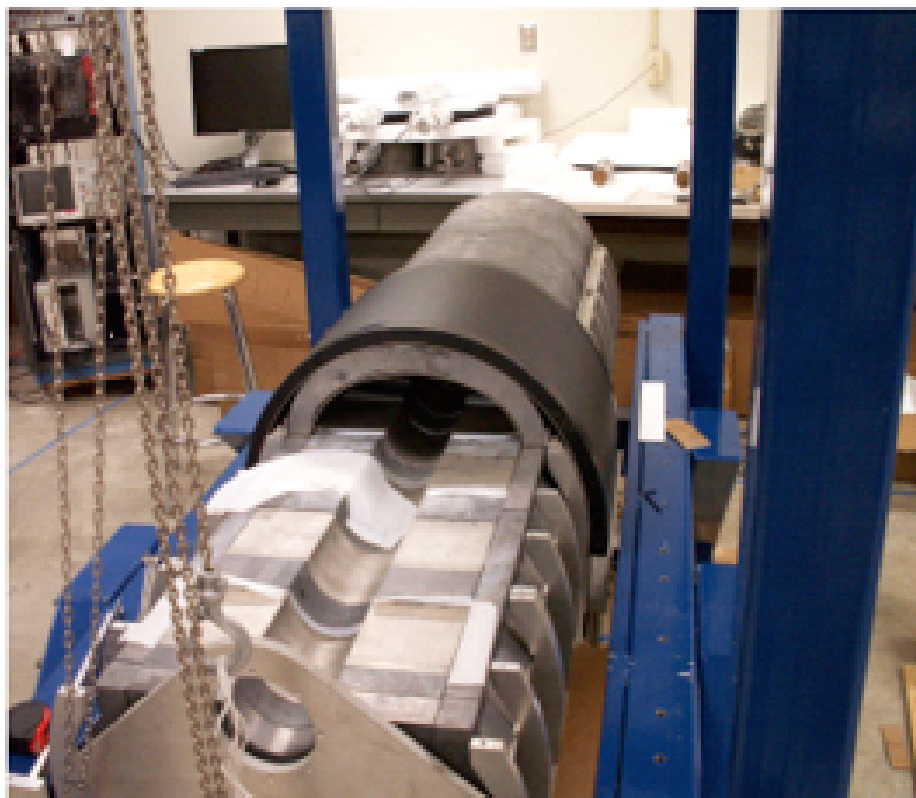

Figure 3. Internal view of NGR logger showing NaI(Tl) and plastic scintillator detectors and lead shielding

## NGR Electronics Crate

It should be noted that a professional nuclear electronics engineer has tuned the NGR electronics. As has been observed through years of operation, the NGR electronics show steady performance and there is usually no need to work with any of the electronic settings, except for voltage tuning in the calibration procedure. In all other cases, call an appropriate person with sufficient training in the NGR electronics before attempting to adjust any of the electronics settings.

The NGR electronics crates (Figure 4) include:

- two NIM bins populated with 21 NIM standard electronic modules

- ISEG high-voltage supply crate for the plastic detectors' PMTs
- PC computer
- Power supply

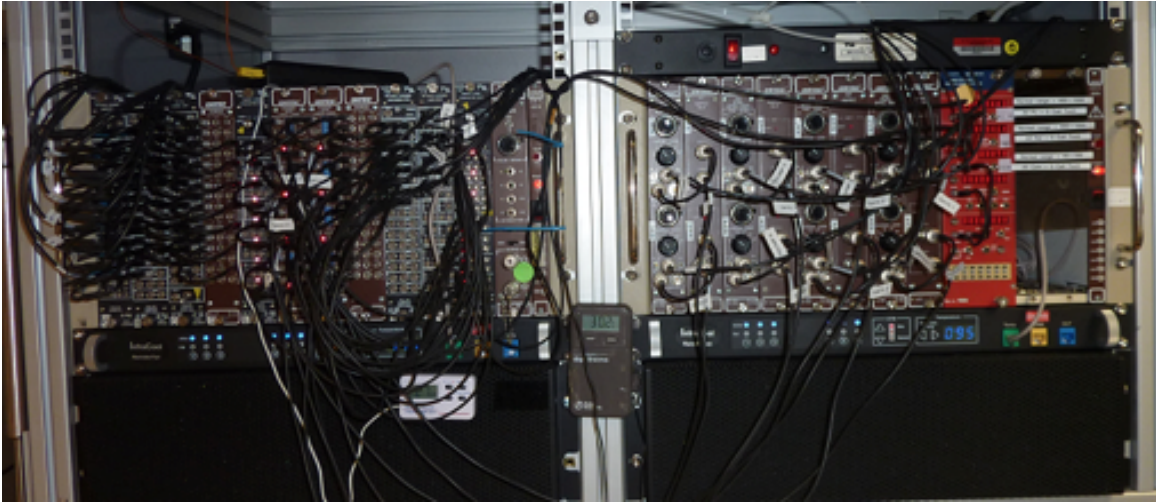

Figure 4. Electronics crate.

The coincidence logic NIM bin (left side) consists of the plastic signal flow units (Figure 5, A through E), coincidence determination units (F and G), NaI signal flow units (H through J), a summary coincidence unit (K), and an ORTEC 480 pulser. A cartoon diagram of the electronics logic is shown below in Figure 6, and for a detailed description of the electronics bin, please see the NGR logger academy Power Point presentation.

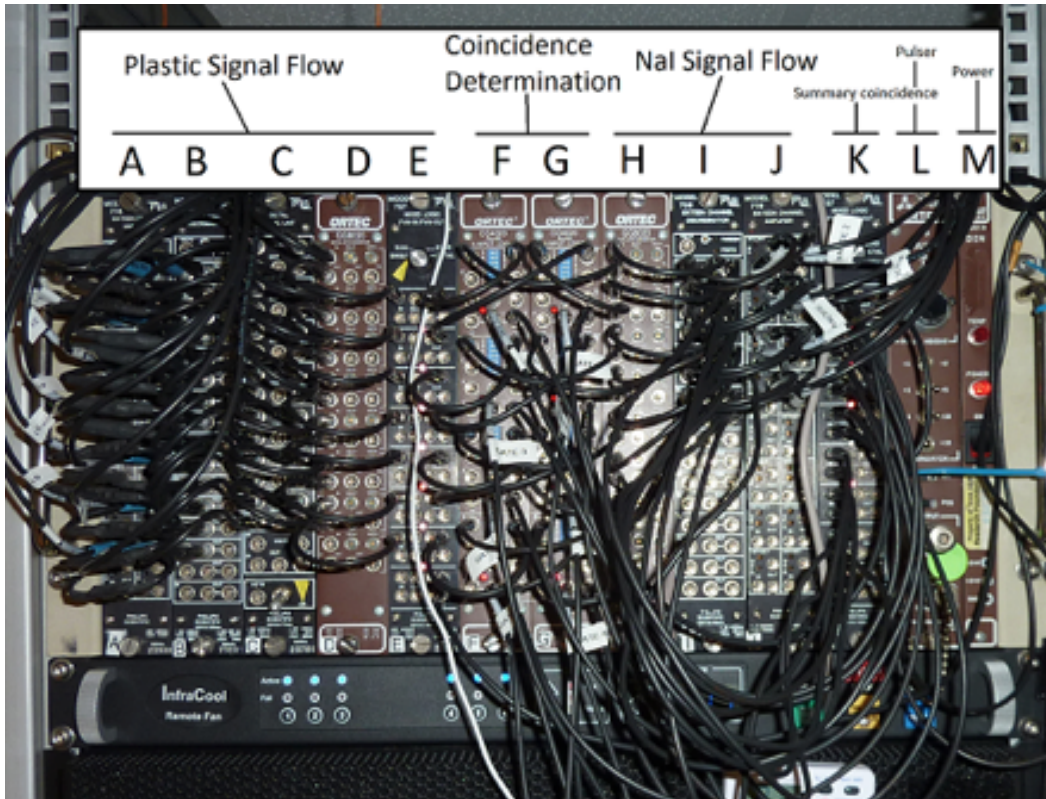

Figure 5. Coincidence Logic NIM Bin

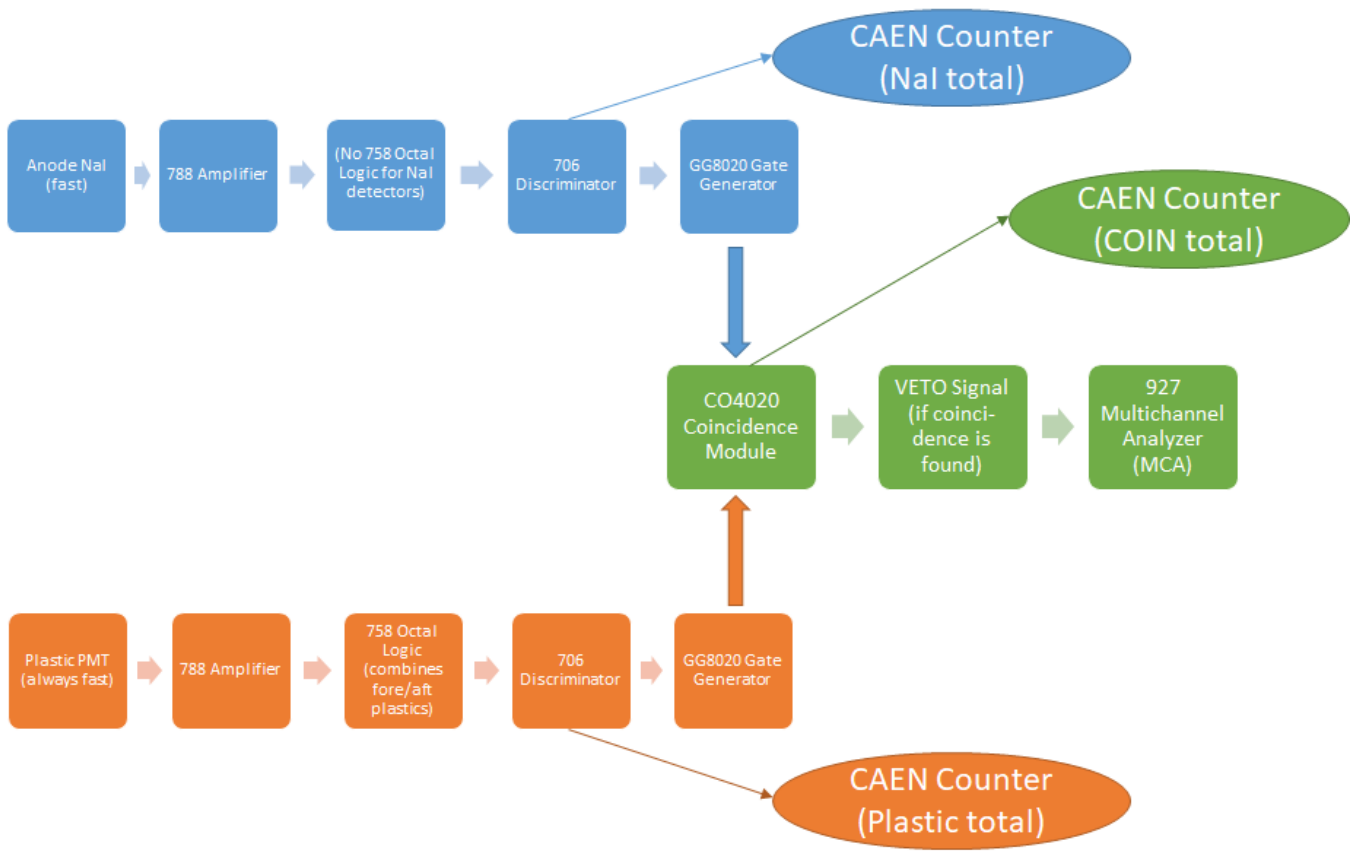

Figure 6. Coincidence Logic Flow Diagram (simplified)

The spectrometric logic NIM bin (right side) consists of NaI signal processing unit (Figure 7), which is eight paired sets of ORTEC 855 amplifiers and ORTEC 927 APSEC multichannel analyzers (MCA).



Figure 7. NaI spectrometric processing unit

The signal summary monitoring panel is a CAEN Quad Scaler and Preset Counter Timer (Figure 8).

- The signal reading in the top display originates from the plastic detectors (normally the sum of all detectors). The normal reading is approximately 400-700 counts.
- The signal reading in the second display originates from the NaI detectors (also usually summed). A normal reading is usually in the range of 400-600 counts if no sample or standard is inside the NGR chamber. Samples and standards will significantly increase this value.
- The signal reading in the third display represents the number of coincidences between the plastic and NaI detector arrays; these are usually in the range of 40-100 counts.



Figure 8. CAEN signal counter depicting summed plastic, NaI, and coincidence values

The electronics crate also contains the ISEG power supply for the plastic detectors, the PC, and various communications electronics (e.g., USB hubs and cables), not pictured.

## PC and UPS System

The PC is used solely for running the NGRL and reviewing data. It must never be connected to the internet or any devices which may interfere with the proper functioning of the instrument and its software. Users should also avoid using the PC for any other purpose while a measurement is running. The APC UPS units provide a short window of normal operation (a few hours at most) if ship's power is down. If ship's power is not going to be restored quickly, the technician should shut down the NGRL following the shutdown procedure.

## Core Delivery System

The core delivery system consists of the M-Drive motor assembly, the NSK actuator, Delrin rails, the titanium core boat, and electronic limit switches. The titanium core boat has a 3.5 cm diameter with welded ends, attached to a Delrin rod that connects it to the NSK actuator. The inherent radioactivity of the boat and the rod are very low and do not affect core measurement.

## Standards

- Assorted 45 cm long epoxy cores with varying amounts of K and Th (Isotope Products Labs, Burbank, CA). NOTE: Although some of the epoxy IPL cores state a U concentration, the U salts were not included in these standards!
- Two 60 cm long plaster cores with U (produced by Dr. Grigor Chubaryan, Texas A&M University Cyclotron Institute)
- Disk-shaped  $^{137}\text{Cs}$ ,  $^{60}\text{Co}$  and  $^{152}\text{Eu}$  radioactive sources (Eckert & Ziegler Isotope Products, Valencia, CA).

The activity of the epoxy and plaster cores is extremely low—significantly lower than background levels—and can be handled safely even for extended periods of time. The disk-shaped sources are 1  $\mu\text{Ci}$  nominal activity and should be handled only by properly trained operators. They do not represent a short-term hazard, but long-term exposure would be harmful.

## Launching the IMS-SRM application

The IMS-NGR software can be launched from the Windows Start menu or from a desktop icon (Figure 9).



Figure 9- NGR Desktop Icon

At launch, the program begins the following initialization process:

- Tests all instrument communications
- Reloads configuration values
- Homes the tray in the track

After successful initialization, the main NGR window will appear (Figure 10).

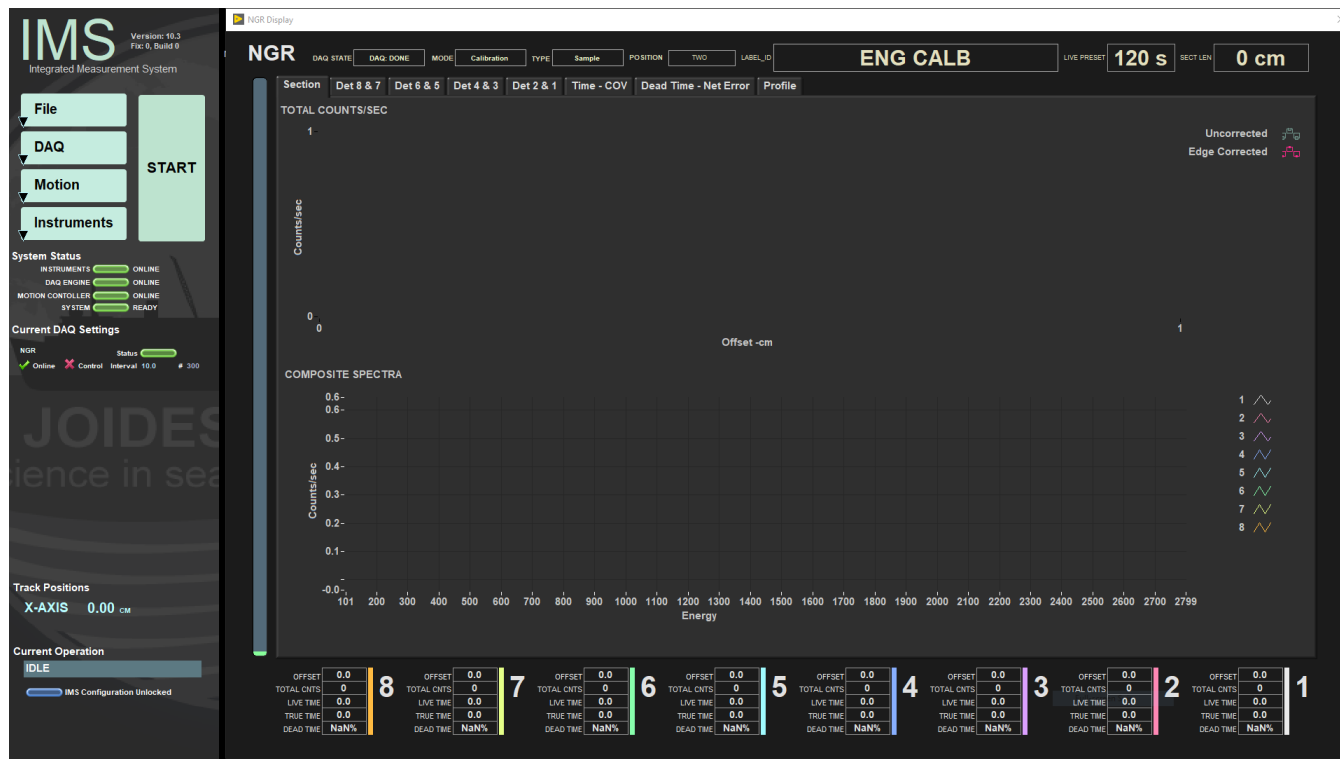

Figure 10- NGR IMS Main Window

## A Quick Introduction to the IMS Program Structure

IMS is a modular program. Individual modules are as follows:

- INST plug-in: code for each of the instruments
- MOTION plug-in: code for the motion control system
- DAQ Engine: code that organizes INST and MOTION plug-ins into a track system

The NGR system, specifically, is built with one INST module (NGR), one MOTION module, and one DAQ Engine module. The IMS Main User Interface (IMS-UI) calls these modules, instructs them to initialize, and provides a user interface to their functionality. Each module manages a configuration file that opens the IMS program at the same state it was when previously closed and provides utilities for the user to edit or modify the configuration data and calibration routines. The five buttons on the IMS-UI window provide access to utilities/editors via dropdown menus as shown in Figure 11.



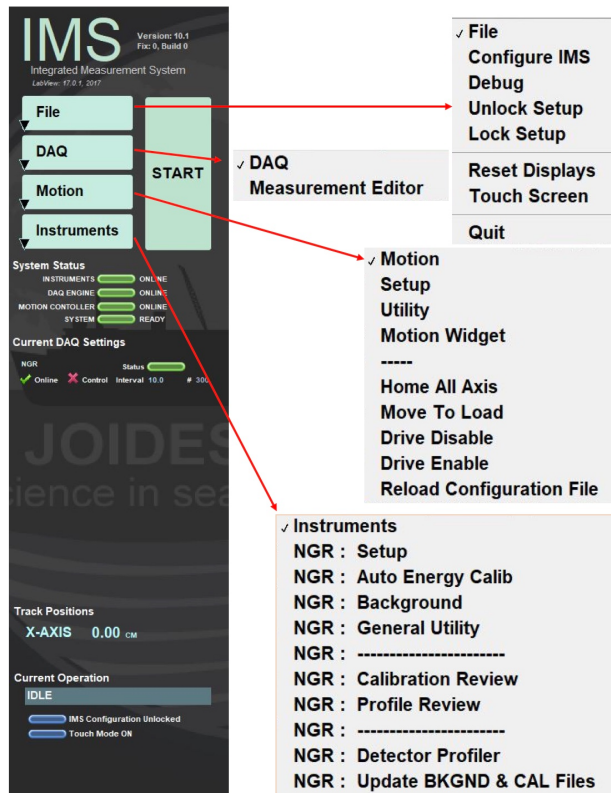

Figure 11: IMS Control Panel Drop down menus

The **Utility** on the main NGR **Motion** menu is used to control of the boat position. There are three basic positions of the boat inside NGR chamber:

- Position I: the edge of the boat (and top of section) is positioned past the edge of detector #8 (starboard detector, furthest from the door)
  - Note that this analyzes "odd" intervals, i.e., 10-20, 30-40, 50-60, and so on.
- Position II: the edge of the boat moves 10 cm outboard (port) so that the edge of the boat is directly over detector #8
  - Note that this analyzes "even" intervals, i.e., 0-10, 20-30, 40-50, and so on.
- Single Detector Scan: For collimator experiments, done only rarely to test each detector's spatial characteristics. It is important to open the rear door with the chain hoist and to remove the rubber stopper before attempting to calibrate detector #8.

The **Utility** display also provides a Home position (loading position) as well as manual fine controls.

## NGRL Startup & Shutdown Procedures

The NGRL utilizes standard NIM modules and electronics crates. The NGRL detectors/electronics are designed to run uninterrupted for years at a time. Switching the power supply off/on is one of the worst operations for the instrument! **Do it only if it is necessary!**

### Shutdown Criteria

Partial (see **Partial Shutdown**) or complete (see **Full Shutdown**) shutdown may become necessary in the following condition

If air conditioning (AC) is not functioning properly

- If atmospheric condensation forms on the NGRL and other instrument surfaces, shut down the high-voltage supplies to all the detectors to avoid an electrical short (partial shutdown).
- Shut down (full shut down) other NGRL equipment (fans, cooling crates, iSEG crates, delivery system, and computer) only when very long AC interruptions with heavy condensation formation are expected or occur. Note that condensation typically occurs when the AC is restored; it can also happen if humid fresh air continues to be pumped in but the AC is not working.
- After partial shutdown, do not power back up for at least 4 hours after AC is functional without additional condensation.

If an extended ship's power supply shutdown is scheduled, or the UPS needs to be changed.

- Full shutdown may be necessary.

- During short power supply interruptions (~15 minutes), the power supply UPS, through which all NGRL electronics connect to the power line should provide enough electricity until power returns; however, it is important to monitor the AC situation and if humidity becomes an issue, a shutdown is needed.
- After full shutdown, wait at least 4 hours after normal AC function returns and condensation disappears.

Figure 12, below, shows the location of the main power switch and the two NIM 4001B crate power switches.

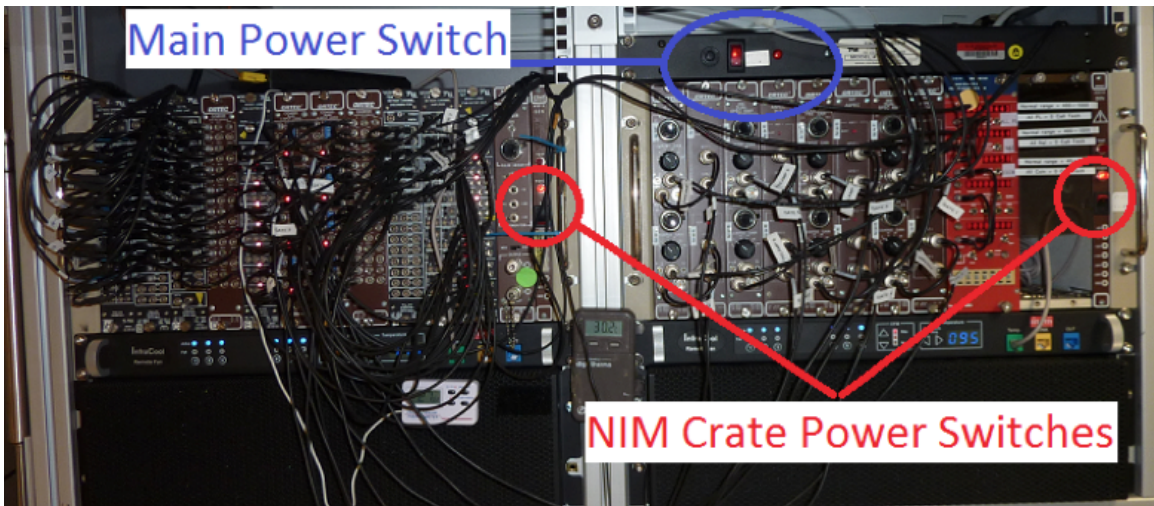

Figure 12. Power switch placement

## Partial Shutdown Procedure

1. Make sure the core boat is at home position outside of the NGR.
2. Start the iSEG High-Voltage Control software using the desktop icon (Figures 13a and 13b) or select **Start > All Programs > iSEGHVwithC an > iSEGCANHVControl** to open the **iSEG Main** window. This program controls the high-voltage power supply for the plastic scintillator PMTs through the iSEG power supply.



Figure 13a. iSEG Hard ware Setup and Main screen

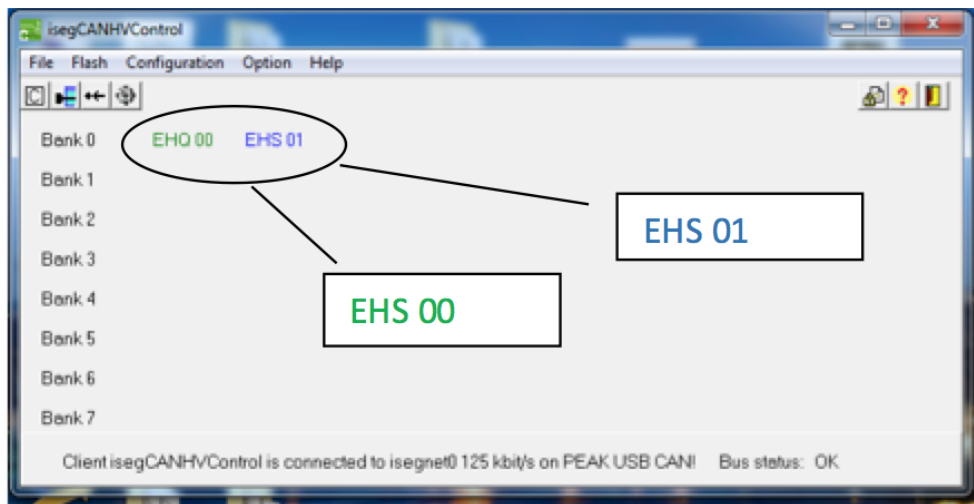

Figure 13b. The controller cards may be the EHS or EHQ model and are labeled accordingly.

- Exit the iSEG program. When the program asks if you wish to ramp the power down on all channels, select **Yes** (Figure 14).

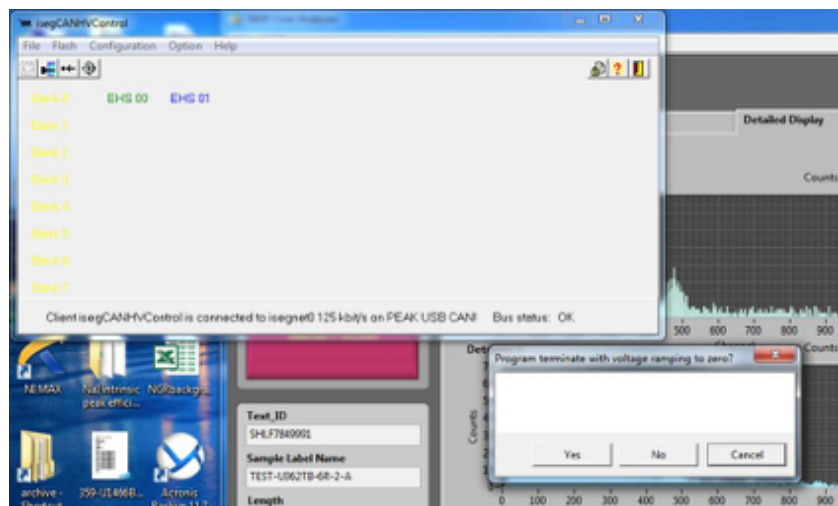

Figure 14. Program termination query.

- Click the **iSEG High-Voltage Control** icon to open the **Main** window.
- Click on the **EHQ00** and **EHQ01** (or EHS00 and EHS01) modules. A window opens for each module (Figures 15a and 15b). Check the following items:
  - $V_{meas}$  values: verify the actual channel voltages have ramped to near zero (1–3 V is acceptable)
  - Current indicators (i.e.,  $I_{meas}$  values) have decreased.
  - Status of all channels is **OFF** (i.e., no green color in the menu status bars).
- Close all iSEG windows after checking the channel voltages and current indicators.

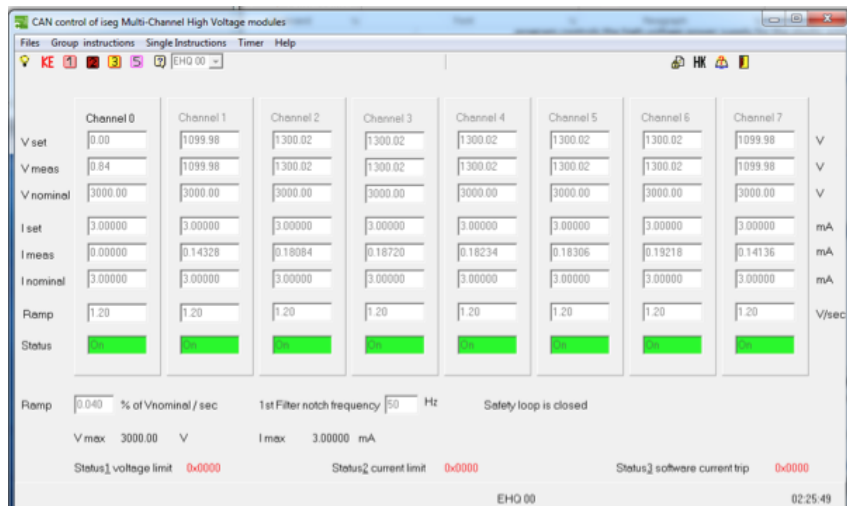

Figure 15a. iSEG Multi-Channel High-Voltage Modules; Ch00.

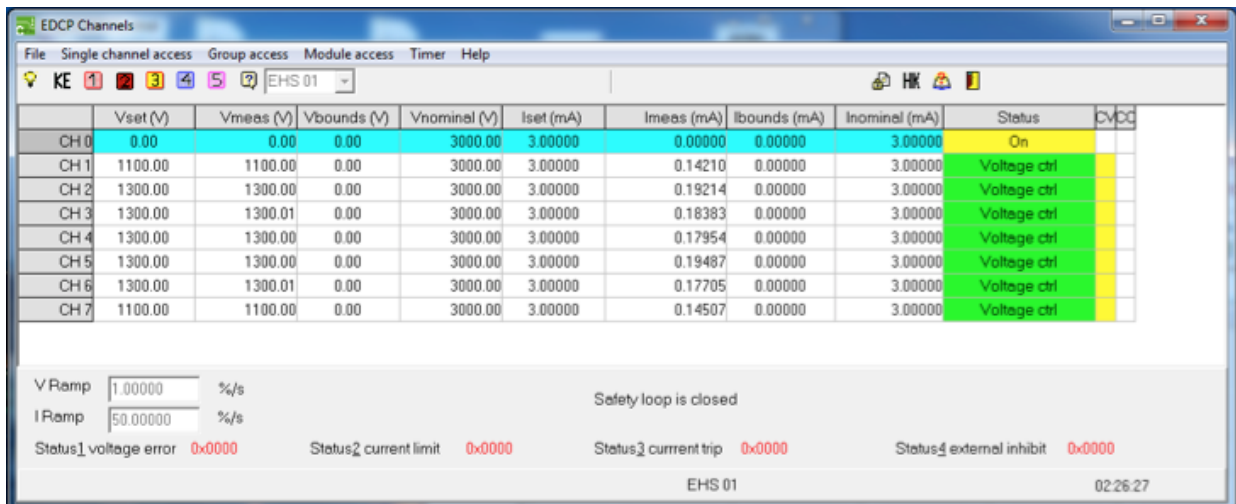

Figure 15b. iSEG Multi-Channel High-Voltage Modules; Ch01.

7. Turn off the NaI detector electronics (right-hand NIM rack next to iSEG crate; Figure 16). This will turn off the high-voltage supply to all 8 NaI detectors. **Do not turn off the left-hand NIM rack (marked with a circled X in Figure 12 below) or the main power (blue circle) at this time.** Leave all other electronics and fans running to prevent additional condensation from forming.

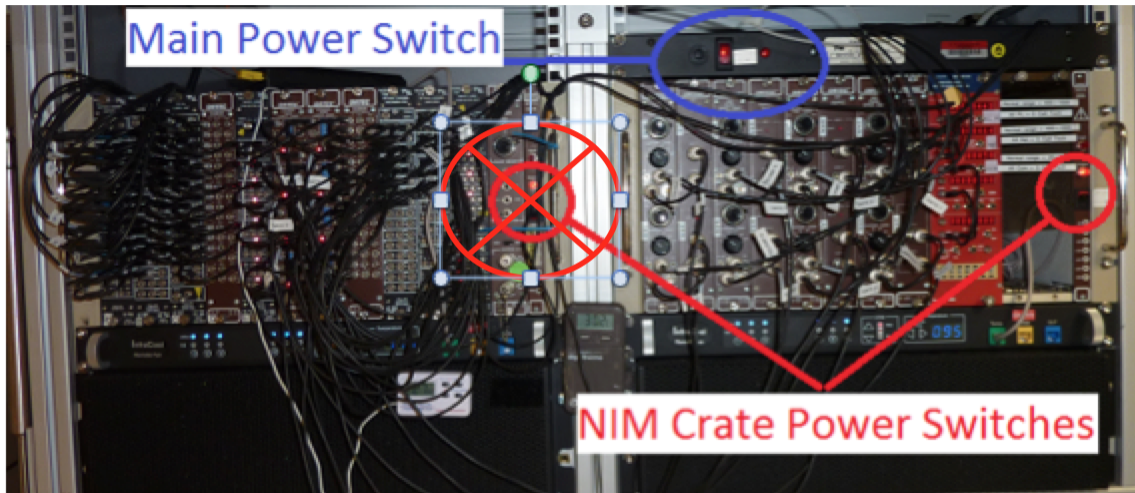

Figure 16. Electronics Crate shutdown switches.

## Full Shutdown Procedure

### Notes

All systems are powered through the uninterruptible power supply (UPS). You will have ~15 minutes before the UPS batteries die.

Take your time. Let the electronics settle. This is not a race. Voltages across any given NaI detector may be monitored with a volt-meter at the bias box with 8 red touch points and a white single ground point. Do **not change the voltage** at any NaI detector at the junction box!!! Remember if you need to switch off the High Voltage you must switch off the whole right-hand NIM crate (right-hand NIM crate button in Fig. 16) as outlined in the partial shutdown procedure, which will turn the high voltage off from all NaI detectors simultaneously.

If time is not a factor, run the check standards and use IMS or Maestro to record channel peak locations. Use a voltage meter to record bias voltages. Once startup procedures are complete, run the standards again to compare values to see if significant changes have occurred. Record both sets of values in the [Bias Voltage Calibration Worksheet](#), and place it in the black binder, on the shelf opposite the electronics.

To be clear, if you follow the steps as numbered below, you will have done the full shutdown correctly.

### Steps:

1. Follow all steps in the Partial Shutdown procedure first.
2. Turn off the power switch to the iSEG voltage control crate (behind iSEG unit).
3. Turn off the fast signal processing electronics (*Figure 17*; leftmost NIM rack).
4. Shut down the computer.
5. Turn off the master power switch above the middle NIM rack (blue circle in *Figure 17*).

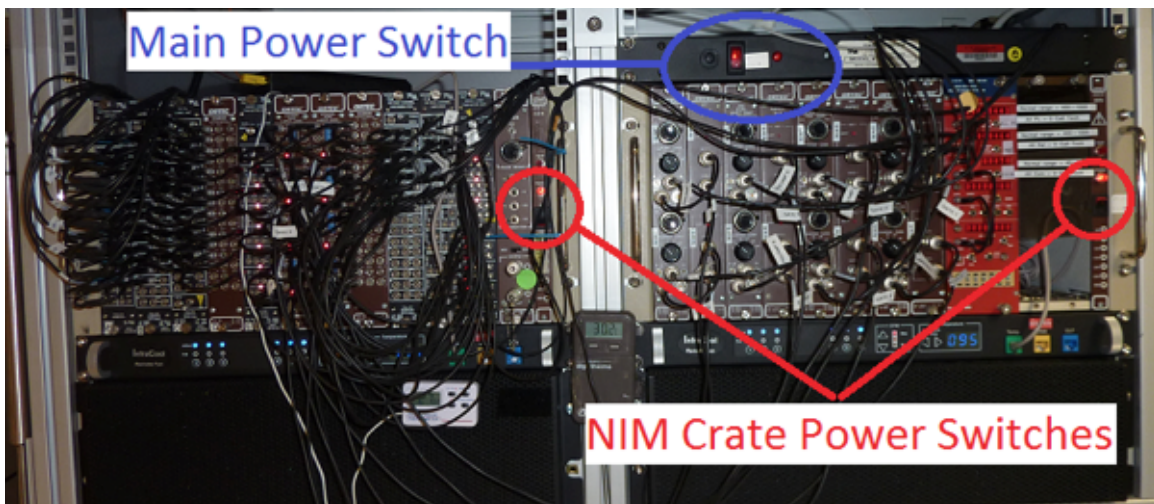

Figure 17. Master Power Switch.

## Startup Procedure

Before proceeding, the air conditioning system should be functioning and atmospheric conditions stable. If stable, ensure the equipment surfaces are dry. Wait at least **4 hours** after the air conditioning turns on.

Note: Allow the exterior surfaces to dry by evaporation so there is some assurance the internal surfaces are dry as well.

If the A/C is stable and the instrument surfaces are dry for **4 hours** after partial or full shutdown, start the NGRL as follows:

1. Turn on the master power button above the middle NIM rack (blue circle in *Figure 17*).
2. Ensure the fans are plugged in and working before proceeding. You can add small external fans under the crates to provide extra cooling.
3. Turn on the computer.
4. Turn on the NaI detector electronics (right-hand NIM rack next to iSEG crate, the right red circle in *Figure 16*), only after ensuring that the fan under it is working.
5. Turn on the fast signal processing electronics (left-hand NIM rack, the left red circle in *Figure 16*).
6. Turn on the iSEG voltage crate power found behind the unit near the power cord.
7. Launch the iSEG control software at the NGR computer (*Figure 15*).

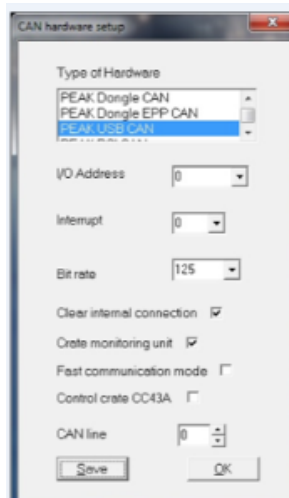

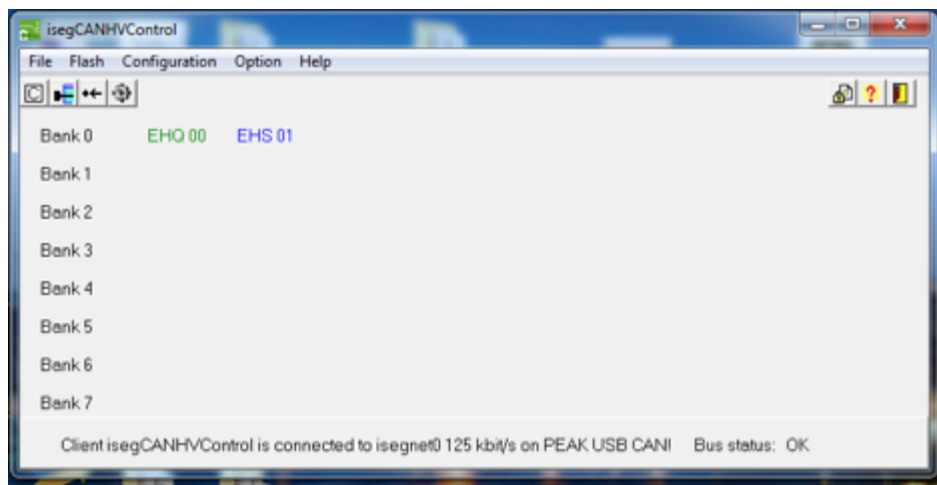

8.

Figure 18. iSEG Hardware Setup and Main screen. The controller cards may be the EHS or EHQ model and are labeled accordingly.

9. Make sure the voltages (Vset) for ESQ00/EHS00 and EHQ01/EHS01 are set (Figure 19). Modify the Vset fields as follows:
  - Channel 0 = 0 (unused and available as a spare channel)
  - Channels 1 and 7 = 1100 V (plastic scintillators in the doors)
  - All other channels = 1300 V (shell-shaped plastic scintillators)
  - If one of the channels on the EHS/EHQ modules has failed, Channel 0 may be in use—be sure you understand which scintillators are connected to which channels, because the door and hoop PMTs require different operating voltages.

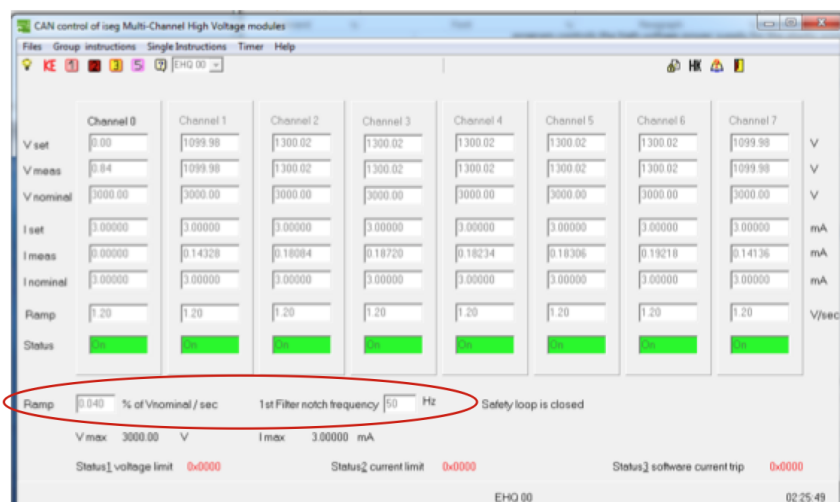

Figure 19. EHS/EHQ 00 and 01 iSEG Multi-Channel High-Voltage Modules Screens; VRamp and IRamp fields are circled in red.

10. Make sure voltage ramp (VRamp) is 5% or lower and the current ramp (IRamp) is 50% or lower. The iSEG software does **not** remember these values between sessions.
11. Click on the **Module access** menu and click **Instructions for all channels > On** (ctrl+o) to start ramping up the voltage.
12. Wait until ramp-up completes (1–2 minutes if proper values are used).
13. Exit the iSEG program.
14. Answer **No** to the prompt when asked to ramp voltages back down. If you answered **Yes** inadvertently, start again at Step 8.

## Initial Instrument Setup

### NGR Configuration

Configuration values should be set during initial setup and configuration by the Physical Properties technician or scientist(s). There should be no need to change these values unless the configuration file is corrupted.

### NGR Instrument General Setup

To open the NGR instrument setup window (Figure 20), select **Instruments > NGR: Setup** from the IMS panel menu (Figure 11).

1. Ensure the values in the window are set as shown in the detector values given are constants and measured from the front door to each detector. Once the offset to the detectors are determined, these values should not change.
2. Click **Accept** to save the changes and write them to the configuration file. Click **Cancel** to revert to previous values.

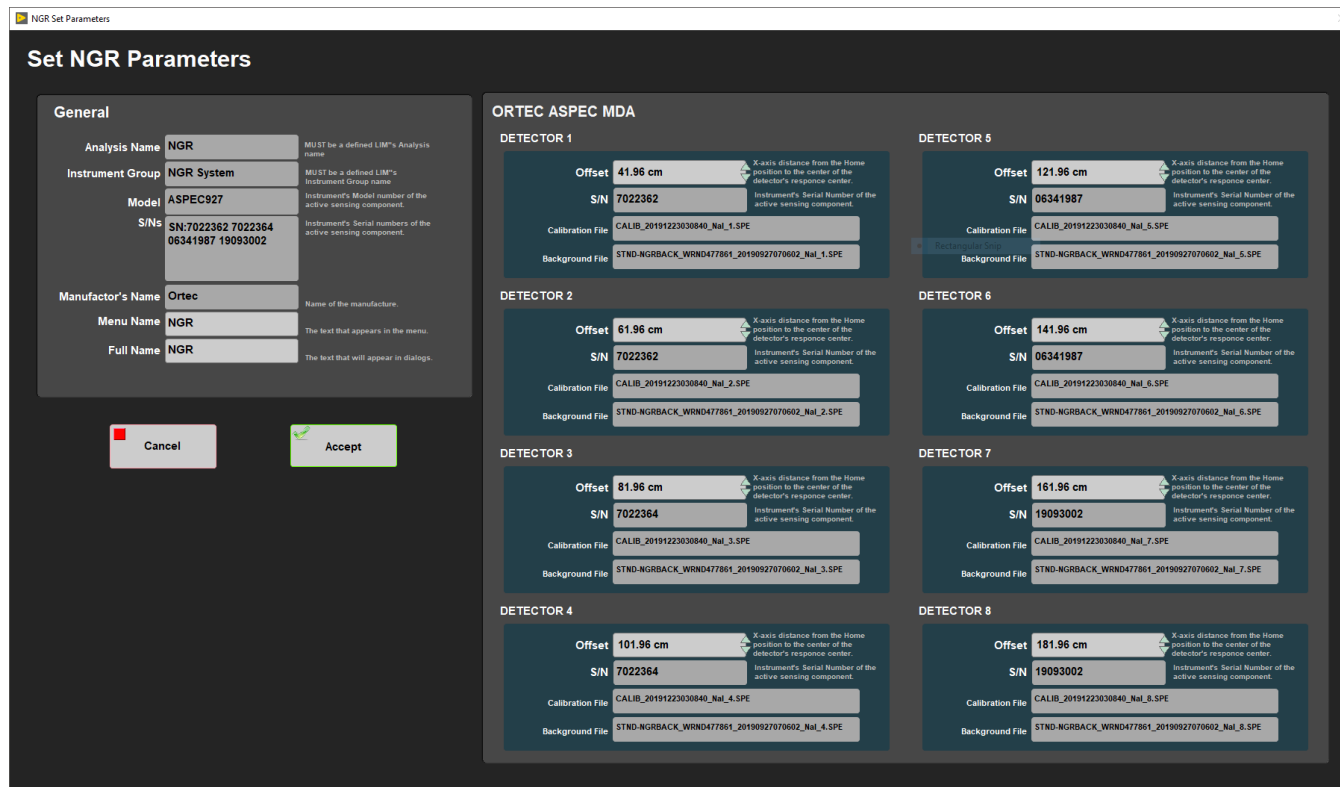

Figure 20. NGR Parameters window

## Motion Control Setup:

1. Motion control should be set during initial setup and further changes should not be necessary. Motion control setup can be accessed by selecting **Motion > Setup** from the IMS panel menu (Figure 11).



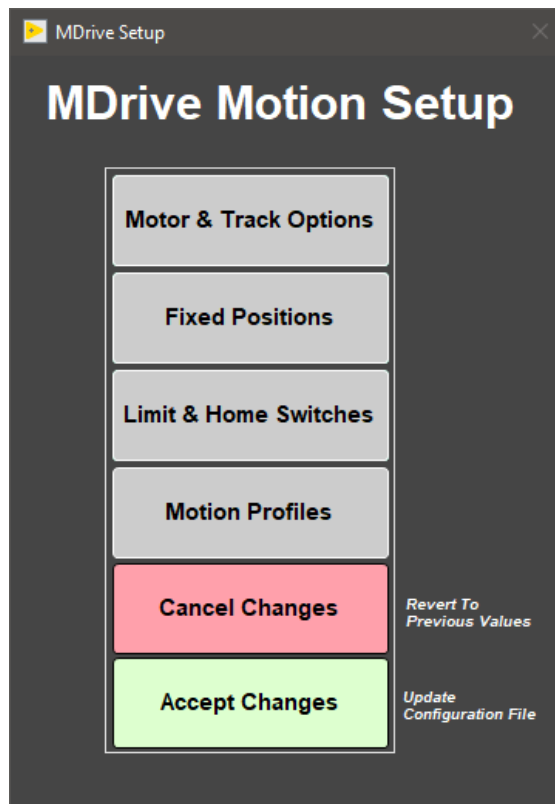

Figure 21. M-Drive Motion Setup

2. The M-Drive Motion Setup control panel will open (Figure 21).
3. The user may select between four setup panels from this window.
  - Motor and Track Options
  - Fixed Positions
  - Limit and Home Switches
  - Motion Profiles

## Motor & Track Options menu

Once these values have been properly set, they should not change. This panel is only for initial setup.

- Make sure to use the values shown for the NGR (Figure 22).
- User should be familiar with the M-Drive motor system prior to adjusting these settings.
- The relationship between motor revolutions and linear motion of the track is defined in this window and is critical to both safe and accurate operation.
- **Select Axis:** In the case of the NGR it is always X.
- **Encoder Pulses/rev:** Defined by the manufacturer of the M-Drive as 2048.
- **Screw Pitch:** Set to 0.0627 (the ratio of 2048 steps per revolution and chain displacement (cm) as a function of the drive gears diameter) (Review???) Now it is set at 2.00000.
- **Gear Ratio:** There is not a reduction gear so this value is set to 1 (Review???) Now it is set to 4.00000.
- **Direction:** Clockwise rotation moves the tray in a positive direction (from home to end of track) (Review???) Now it is set for turn in a CCW direction for positive Encoder counts.
- Click the **Motion Utility** to open the Motion Utility window (Figure 23) and test the settings. Click **Close Utility** to exit this window.
- Click **Accept** to save the values or **Cancel** to return to previous values.

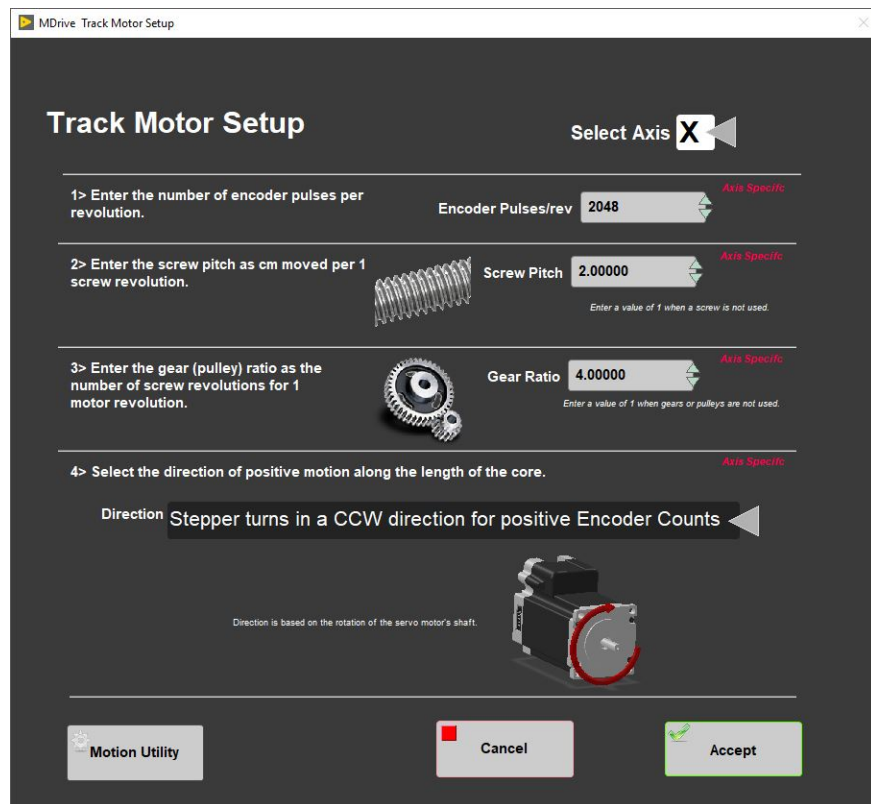

Figure 22. NGR Motor and Track Options Setup window

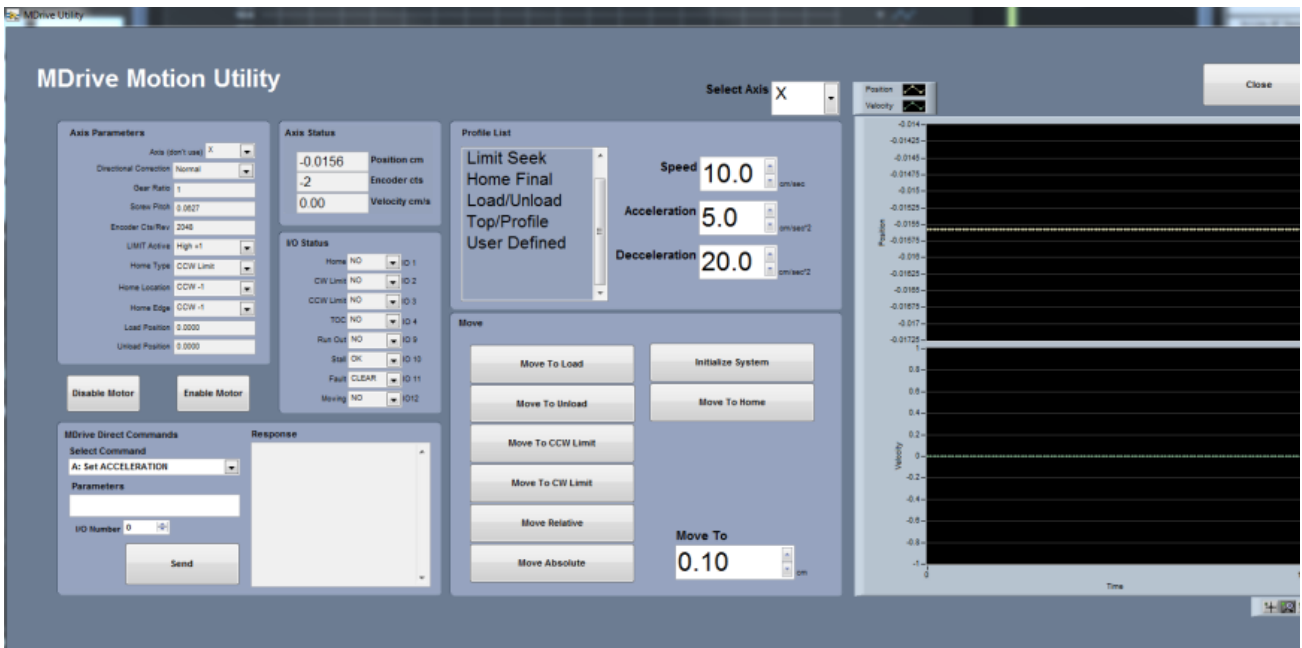

Figure 23. Motion Utilities window

## Fixed Positions menu

Once these values have been properly set, they should not change. This panel is only for initial setup.

In this window (Figure 24) the user may define fixed track locations used by IMS motion control. For the NGR make sure to use these value unless there has been a physical change to the system.

- **Select Axis:** In the case of the NGR it is always X.
- **Max Section Length:** Maximum length of section that can be placed in the track. This value is set to 150 cm.
- **Track Length:** Distance in cm between the limit switches. Use the **MDrive Motion Utility** (Figure 23) to determine this value by moving from limit switch to limit switch plus the length of the tray used.
- **Load and Unload Position:** For the NGR set to 0. This will always bring the tray back to the sample load end after a measurement sequence.
- **Top-of-Section Switch:** Not used.
- **Top-of-Section Switch Offset:** Not used.
- **Fast Offset:** Not used.
- **Run Out Switch?:** Not used.
- Click the **Motion Utility** to open the Motion Utility window (Figure 23) and test the settings. Click **Close Utility** to exit this window.
- Click **Accept** to save the settings. Click **Cancel** to return to previous values.

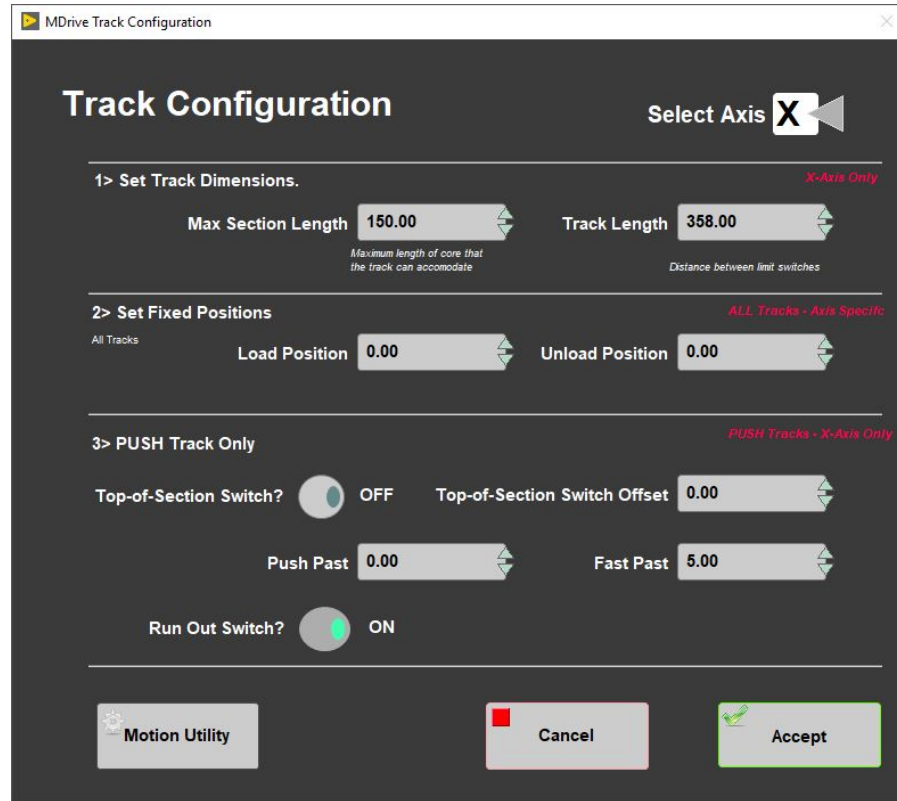

Figure 24. NGR Track Configuration window

## Limit & Home Switches window (Figure 25)

Once these values have been properly set, they should not change. This panel is only for initial setup.

- This panel is used to define the orientation of the track system, limit switches, and the home switch. The M-Drive can be used with either a dedicated Home switch or a limit switch as a home switch. In the case of the NGR track we have a home switch.
- **Select Axis:** In the case of the NGR it is always X.
- **Select Track and Home Geometry:** For the NGR, select CW limit.
- Click the **Motion Utility** to test the settings.
- Click **Accept** to save the settings. Click **Cancel** to return to previous values.



Figure 25. NGR Limit and Home Switches window

## Motion Profiles

The motion profiles window (Figure 26) can be used to adjust the speed and acceleration profiles used by the track for various types of movements.

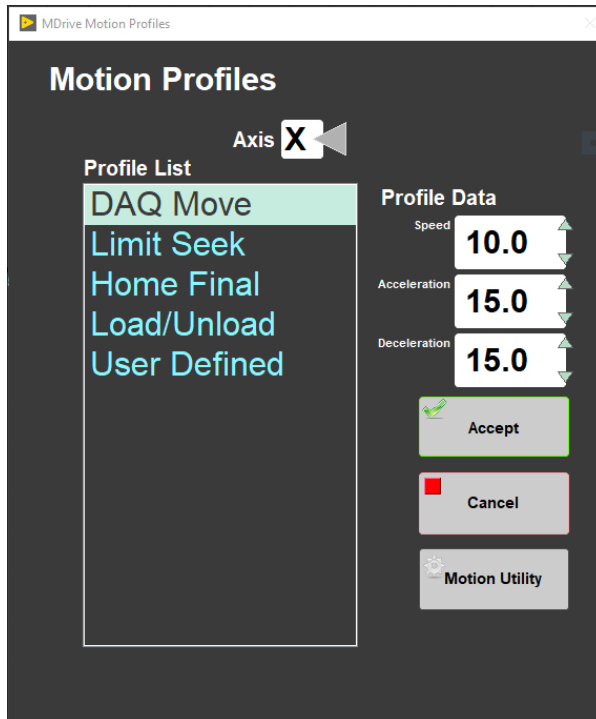

Figure 26. Motion Profiles window

- **DAQ Move:** This profile controls the speed of moves between measurement positions. Now is set to: 10.0 for Speed, 15.0 for Acceleration and 15.0 for Deceleration.
- **Limit Seek:** Used for tripping end-of-travel optical switches. The parameters now are: Speed 5.0, Acceleration 10.0 and Deceleration 80.0.
- **Home Final:** This profile finds the final location of the home switch. *Do not exceed 3 cm/sec. Do not use a large acceleration value, but always use a large deceleration value.* The parameters now are: Speed 0.5, Acceleration 2.0 and Deceleration 80.0.
- **Load/Unload:** This profile is used for moving the tray in and out of the NGR. The parameters now are: Speed 18.5, Acceleration 2.5 and Deceleration 5.0.
- **User Define:** This profile is used for testing only in the **Motion Utilities** program. The parameters now are: Speed 5.0, Acceleration 5.0 and Deceleration 5.0.
  - Click **Motion Utility** to open the **Motion Utility** window and test the settings.

Click **Accept** to save the settings. Click **Cancel** to return to previous values.

## Background Measurement

Measure the background periodically, whenever the ship changes latitude by more than 1-2 degrees and at least twice an expedition. A data file is generated for each NaI detector and measurement position. The titanium boat with an empty core liner are no longer used in the background measurements as of Exp. 368X. The background measurement is taken for a much longer period of time for a good statistical spectrum. Typical core measurement time is 300 seconds per position; the background is normally done for 21,000 seconds (almost 6 hours for a single measurement position). On the main (left-hand) IMS panel, go to **Instruments > NGR: Background** (Figure 11) to start a measurement.

During data reduction for core analysis, the background spectrum is normalized to its equivalent at 300 seconds' duration. For example, if the background at channel 200 of the spectrum were 6,400 counts in the 21,000-second background experiment, that specific channel's background would be normalized as follows:

$$6,400 \text{ counts} \times 300 \text{ seconds} / 21000 \text{ seconds} = 91.4 \text{ counts}$$

## Calibration Procedures (REVIEW WITH PP TECHNICIANS)

Even uncalibrated, the NGRL will still produce and record signals, but significant error will arise.

The multichannel analyzer (MCA) collects the analog signal from the PMT and divides it into channels, but without energy calibration, it is impossible to characterize the energy into scientific units (i.e., MeV). Radioactive materials of known energy are placed within the NGRL at specific locations, and IMS is used to ensure that the signals from the standards lie in their proper channels.

In addition, it is necessary to calibrate the instrument in the time domain. If this is not done, the active shielding will not function properly without proper timing of the anti-coincidence logic. This will decrease the effectiveness of the active shielding. This was performed during the initial instrument validation.

## 1. Collimated Sources (REVIEW WITH PP TECHNICIANS)

This calibration is done using IMS, placing the collimated sources on the top of each detector.

### Equipment Needed

- Fan-collimated Lead holder for containing the Co and Cs sources
- $^{60}\text{Co}$  radioactive source (nominal activity 1  $\mu\text{Ci}$ ; half-life 5.27 years)
- $^{137}\text{Cs}$  radioactive source (nominal activity 1  $\mu\text{Ci}$ ; half-life 30.2 years)
- 77 IV Multimeter (cabinet NGR 1)
- NGRL Bias Voltage Calibration Worksheet (NGRL Bias Voltage Calibration Worksheet.pdf in the "NGR Manual/Log" binder. Attached at the end of this section.)

Warning: The radioactive sources (kept in a black lockbox; ask a technician if you need them) generate a relatively small amount of radiation, but the user should take care to minimize interaction with them. The sources should be returned to the radioactive standards lockbox as soon as the procedure is finished.

Note: The  $^{60}\text{Co}$  source has a much shorter half-life than the  $^{137}\text{Cs}$  source as stated above. Getting low  $^{60}\text{Co}$  peaks probably does not mean a problem with the instrument: check the date of the standard disk first and determine if the remaining activity seems reasonable compared to past experiments. When new, the  $^{60}\text{Co}$  double peak is roughly the same size as the  $^{137}\text{Cs}$  single peak; as the sources age, the  $^{60}\text{Co}$  double peak will shrink relative to the  $^{137}\text{Cs}$  peak.

### Energy Calibration Procedure

1. Place the collimated Lead holder into the boat, ensuring that it clips over the end closest to the logger.

- On the main IMS (left-hand) panel, go to **Instruments > NGR: Energy Calib**, the **Energy Calibration Setup** window will be open (Figure 27), check the values and click **START** to allow the calibration to commence. The calibration process takes approximately 20 minutes to complete.

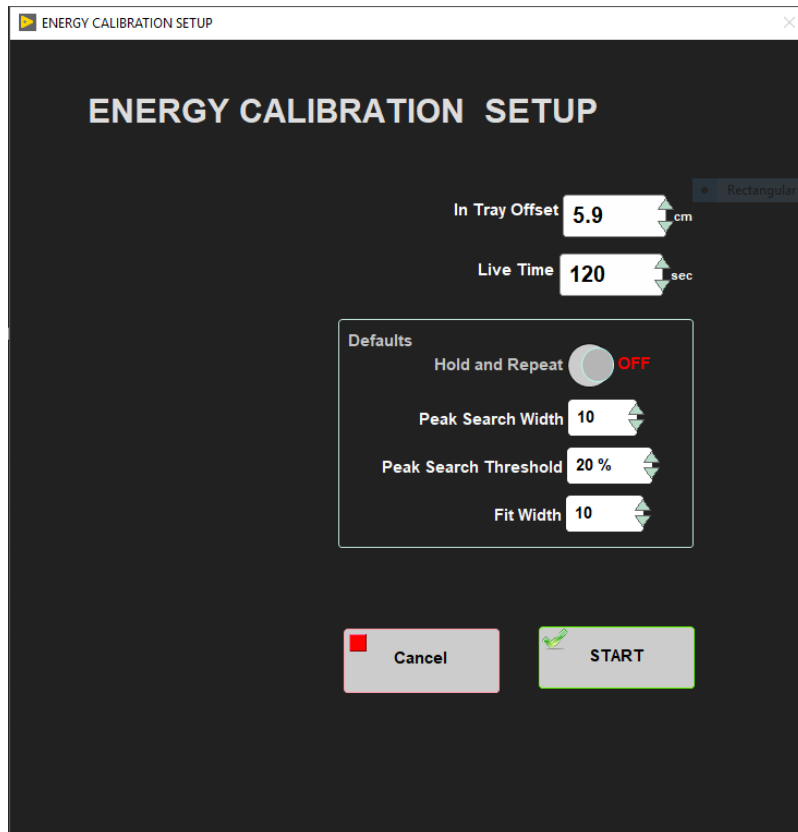

Figure 27. Energy Calibration Setup using collimated sources

- In Tray Offset:** Distance from the top of the boat to the opening in the collimator. This used to be 5.9 cm but should be checked if a new collimator is built. Using this offset will place the sources on top of the detectors.
- Live Time:** Sample time for each detector. Should not be less than 120 sec.
- Hold and Repeat:** If you select ON, the measurement will continue on the same detector until it is switched off.
- Peak Search Width:** Definition??? A usual value is 10.
- Peak Search Threshold:** Definition??? A usual value is 20%.
- Fit Width:** Definition??? A usual value is 10.

3. If during the calibration the position of the  $^{137}\text{Cs}$  peak is not between channels 224-228, the bias of that detector should be changed following the procedure explained below. When the calibration finishes, review the values for each detector and click **Accept** if everything is correct, if not, you can do it again by selecting **Cancel**.

## 2. Non-Collimated Sources (REVIEW WITH PP TECHNICIANS)

This calibration is done using IMS, placing the non-collimated sources between detectors. The calibration of each detector will be performed with the sources 10 cm away from the detector.

### Equipment Needed

- NGR Metal core
- $^{60}\text{Co}$  radioactive source (nominal activity 1  $\mu\text{Ci}$ ; half-life 5.27 years)
- $^{137}\text{Cs}$  radioactive source (nominal activity 1  $\mu\text{Ci}$ ; half-life 30.2 years)
- Plastic container for holding the sources
- 77 IV Multimeter (cabinet NGR 1)
- NGRL Bias Voltage Calibration Worksheet (NGRL Bias Voltage Calibration Worksheet.pdf in the "NGR Manual/Log" binder. Attached at the end of this section.)

**Warning:** The radioactive sources (kept in a black lockbox; ask a technician if you need them) generate a relatively small amount of radiation, but the user should take care to minimize interaction with them. The sources should be returned to the radioactive standards lockbox as soon as the procedure is finished.

Note: The  $^{60}\text{Co}$  source has a much shorter half-life than the  $^{137}\text{Cs}$  source as stated above. Getting low  $^{60}\text{Co}$  peaks probably does not mean a problem with the instrument: check the date of the standard disk first and determine if the remaining activity seems reasonable compared to past experiments. When new, the  $^{60}\text{Co}$  double peak is roughly the same size as the  $^{137}\text{Cs}$  single peak; as the sources age, the  $^{60}\text{Co}$  double peak will shrink relative to the  $^{137}\text{Cs}$  peak.

## Energy Calibration Procedure

1. Place the metal core into the boat, ensuring that hole 8 is closest to the logger (Figure 28).
2. Place the sources inside the plastic holder and insert it into the hole between holes 8 and 7. Note that the red marks on the plastic holder should be aligned with the red marks on the metal core.

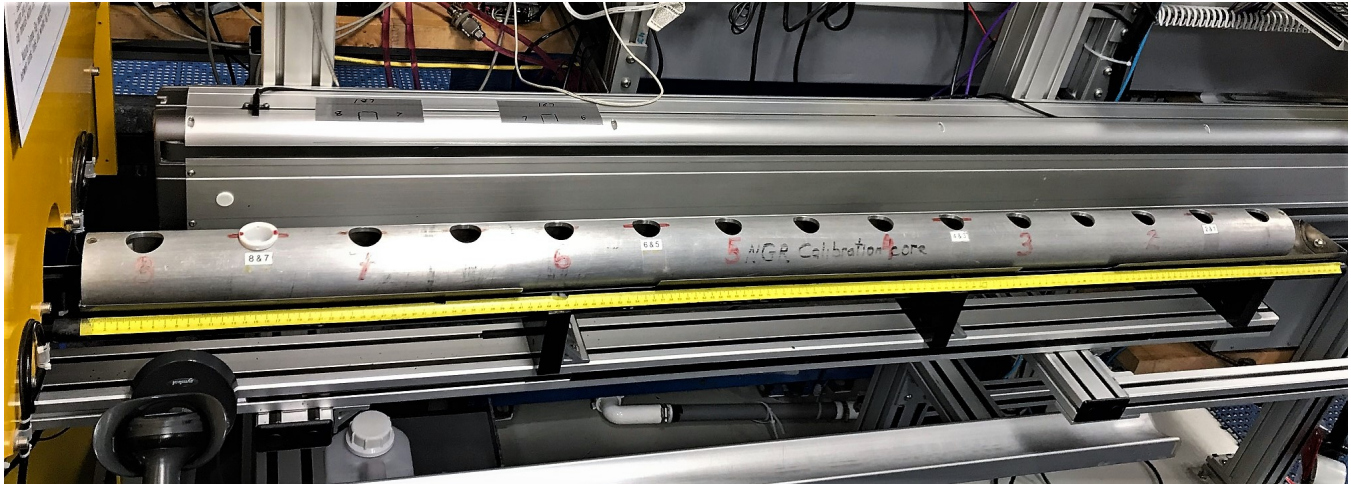

Figure 28. Proper positioning of the NGR metal core and the plastic source holder for performing a calibration.

3. On the main IMS (left-hand) panel, go to **Instruments > NGR: Energy Calib**, the **Energy Calibration Setup** window will be open (Figure 27), check the values and click **START** to allow the calibration to commence. The calibration process takes approximately 20 minutes to complete.

- For placing the sources 10 cm away from the detectors, the Setup offset should be set to 5.0 cm (Figure 29).



Figure 29. Calibration offsets for non-collimated sources: For placing the sources between detectors use a 5 cm offset. For placing the sources on top of detectors use a 15 cm offset.

*The plastic holder should always be placed between holes 8 and 7.*

- When using weaker sources for a calibration, the sources can be placed on top of the detectors. The source holder stays in the hole between holes 8 and 7, but the offset has to be set to 15.0 cm. Never place the plastic holder in hole 1 or 8, because the metal core end cap prevents it from going all the way in, and it will not have enough space to go into the NGRL (Figure 30).



Figure 30. Don't place the plastic holder in hole 8 or 1, it can damage the NGRL.

4. If during the calibration the position of the  $^{137}\text{Cs}$  peak is not between channels 224-228, the bias of that detector should be changed following the procedure explained below. When the calibration finishes, review the values for each detector and click **Accept** if everything is correct, if not, you can do it again by selecting **Cancel**.

### Verifying Threshold Values (REVIEW WITH PP TECHNICIANS)

After completing an energy calibration in the IMS software, the user must verify the threshold values selected by IMS in the .ini file.

1. Close the IMS software
2. Open the NGR Threshold Check spreadsheet. [IMS-NGR threshold Verification.xlsx](#)
3. Open the .ini file for the NGR
4. Copy the slope and intercept values for each detector from the .ini file into the first tab of the NGR Threshold Check spreadsheet
5. In the second tab of the NGR Threshold Check spreadsheet, locate the first channel **containing 100 keV** and record the channel number. This is the "hand picked" channel.
  - a. Each channel covers a range of keV, approximately 3 keV. The value shown in the spreadsheet is the initial voltage.
6. Compare the "hand picked" channel number to the IMS selected channel number in the .ini file. The channel number will be listed with a text string similar to: **value 0.NGR927.CALB.>100 Kev**.
7. Update the >100 keV threshold values to the hand picked threshold values.
8. Save the .ini file
9. Reopen IMS
10. Reopen the .ini file and verify that the threshold values are set properly. If IMS was open when the .ini file was edited, the changes made manually may have been overwritten. It is important to verify that the manual edits stayed in the .ini file after IMS is launched.

### Tuning the NGRL Voltage Settings (this section may not be applicable for IMS version - confirm during next Exp.) (REVIEW WITH PP TECHNICIANS)

If the normal energy calibration procedure does not bring the  $^{137}\text{Cs}$  peak (662 keV) close to channel #226, then it may be necessary to tune the NGRL's detector voltage and then repeat the calibration procedure. This is done detector-by-detector as noted below.

Warning! This procedure may be necessary at the start of any expedition as a response to drift, but should not be undertaken without clearly understanding the process.

The total number of channels in the high voltage divider of the MCA is 1024. The  $^{137}\text{Cs}$  decay has a peak of 662 keV and the two  $^{60}\text{Co}$  peaks are 1173.2 and 1332.5 keV, respectively. Normally the 662 keV  $^{137}\text{Cs}$  peak appears close to channel #226, however this will drift over time with a different drift rate for each detector. By changing the voltage in the bias adjustment box (Figure 31), the operator can control the position of a given peak and bring it to (or close to) the appropriate channel. If the  $^{137}\text{Cs}$  peak is not within a few channels of #226, it may be necessary to use the adjustment box to adjust the peak. Using the Maestro program, the operator can see the position of the peak from the sources and make adjustments. The potentiometers in the bias adjustment box are very sensitive and nonlinear, so use a very light touch to avoid moving the peak too far.





Figure 31. NaI bias adjustment box

The gross voltage of the PMT should be in the range of 650 to 750 volts; the leads for the bias adjustment box have been stepped down to the equivalent in millivolts, so a voltmeter can be used without the presence of dangerous voltages. Thus, the voltmeter should display a value somewhere between 650 and 750 mV. Each detector has a positive (red) lead; they share a common ground (white) lead. The row of silver screws above the numbers are the potentiometers.

**Step-by-step procedure for setting the NaI detector bias voltage:** (EDIT TO REFLECT NEW IMS CALIB METHOD!) (REVIEW WITH PP TECHNICIANS)

1. Place the lead source holder on the titanium boat, making sure that holder is slotted on the Ti boat correctly
2. Ensure no obstructions are on the track or inside the chamber.
3. From the main NGRL screen, select the Track Utility dialog box and click "Calibration position" to send the core into the chamber.
4. Open the ORTEC Maestro program. From the top menu choose Display/Detector/00001 PC to open the signal spectrum for NaI detector #1. Clear the previous spectrum, if any.
5. On the Acquire menu, select MCB Properties and on the properties window, ensure that the gate is set to "anticoincidence" on the ADC tab and that the Live time on the Presets tab is approximately 60 seconds. Close the properties box.
6. On the Acquire menu, click on Start and allow the spectrum to be collected. It should look like one above (INSERT SCREENSHOT OF MAESTRO HERE, Figure XX). Bring the Maestro cursor to the middle of the  $^{137}\text{Cs}$  peak and check the corresponding channel number on the bottom of the screen. If this number is 224 to 228, a bias voltage correction is not necessary, but could still be performed if desired. (Expected behavior is for the channel number for  $^{137}\text{Cs}$  to be  $226 \pm 2$  channels (Figure XX).)
7. If the drift is sufficiently large to require an adjustment, or if the spectrum appears compressed or stretched compared to the other detectors, perform a bias voltage tuning.
8. Use a multimeter. Set it to DC current in the millivolt range. Read the voltage in the bias adjustment box. The multimeter's black probe goes into the white fitting and the red probe into the appropriate red fitting for the detector being examined (Figure 32).
9. Note the current voltage setting and the position of the pulser channel (if the pulser is used), the  $^{137}\text{Cs}$  662 keV peak position, and the  $^{60}\text{Co}$  1170 and 1330 keV peak positions in the table below (Table 2).
10. Using the potentiometer screw just above (aft of) the red fitting, gently turn the screw to increase voltage (clockwise rotation) if the  $^{137}\text{Cs}$  peak is less than channel 226, or to decrease voltage (counterclockwise rotation) if the  $^{137}\text{Cs}$  peak is greater than channel 226. Note that you must rerun the 60-second acquisition (step 6) each time to see the new channel.
11. Once you have set the  $^{137}\text{Cs}$  peak close enough to channel 226, record the new voltage setting and the new positions of the pulser channel, the  $^{137}\text{Cs}$  662 keV peak, and the  $^{60}\text{Co}$  1170 and 1330 keV peaks on the table.
12. You must now set the software calibration as noted in the "Energy Calibration Procedure" section above. Once you have done this for detectors #1 and #2, repeat for the other detector pairs.

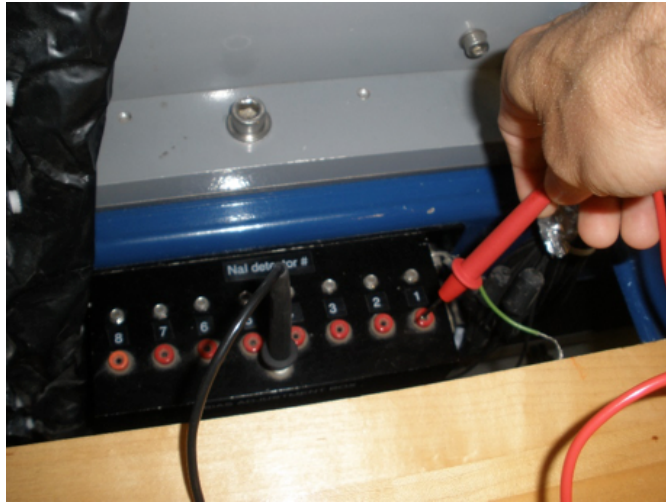

Figure 32. Insert the multimeter probes into the bias detector box to measure the voltage. Black to white. Red to red

NGRL Bias Voltage Calibration Worksheet								
Technician: _____		Exp: _____			Date: _____			
Nal det #	channel corresponding to keV reading before calibration				channel corresponding to keV reading after calibration			
	multi- meter reading	137 Cs Peak keV Channel	60Co channels		multi- meter reading	137 Cs Peak keV Channel	60Co channels	
			1170 keV	1330 keV			1170 keV	1330 keV
1								
2								
3								
4								
5								
6								
7								
8								

Table 2. NGRL NaI Detector Bias Voltage Table

**Download a Copy**

[NGRL Bias Voltage Calibration Worksheet.pdf](#)

## ORTEC 480 Pulser

It should be noted the ORTEC 480 pulser as well as the pocket pulsers can be used to generate a signal for the NaI detectors. At a setting of 30 mV for 50 Ohm input impedance, the signal from the ORTEC 480 will fall onto approximately channel 236. It will be necessary to set the voltage of the pulser with an oscilloscope, and detailed procedures can be found in the NGRL electronics manual.

The pulsers are not necessary unless the user wishes to see a sharply-defined channel marker to facilitate adjustments. The user can complete the energy calibration without using either type of pulser.

## Energy Calibration Evaluation

After all eight detectors are calibrated; IMS shows energy-corrected results. Core spectra from these detectors display both channel and energy information. The ASCII files with the calibration coefficients are saved and available for the data reduction. The operator should evaluate the position of the K peak (1.460 MeV) in core samples to ensure the calibration has been recorded with reasonable results. (Known U and Th peaks can be used for this purpose as well.)

When the  $^{137}\text{Cs}$  peak is calibrated to channel  $226\pm 2$ , the  $^{40}\text{K}$  peak should fall roughly at channel  $498\pm 4$ , in the same direction of error as the  $^{40}\text{K}$  peak because energy vs. channel is quite linear. (If the  $^{137}\text{Cs}$  peak is found at channel 224, the  $^{40}\text{K}$  peak is likely to lie at or about channel 494; if the  $^{137}\text{Cs}$  peak is found at channel 228, the  $^{40}\text{K}$  peak is likely to lie at or about channel 502.)

The system is now calibrated sufficiently to perform analysis on a total counts basis. Further calibration with known values of K, U, and Th (KUT) must be performed before KUT abundance can be determined. The scientist must do this reduction for KUT from the spectral data and no automated process exists for this.

## Calibration of NGRL Spectra for Analysis of $^{40}\text{K}$ , $^{238}\text{U}$ , and $^{232}\text{Th}$ (“KUT”) Concentrations

Note: that the NGRL software does not produce “KUT” data. The spectral data (found in the ZIP file produced by the NGRL software) is there, but significant post-acquisition work (beyond the scope of the IODP marine technician’s duties) is needed to derive it.

The raw spectrum recorded in the file contains the spectral information to identify the  $^{40}\text{K}$  line and the several  $^{232}\text{Th}$  and  $^{238}\text{U}$  lines. In order to use this information to produce calibrated % K and ppm Th and U, it is necessary to measure the intensity of the related peaks from standards of known activity. (It is also necessary to have a good enough quality spectrum, which for geologic cores with low activity (<10-15 cps) may require longer read times as well as additional calibration.)

Aboard the *JOIDES Resolution*, a number of epoxy core sections containing K and Th salts are available with different levels of activity. Note: Even if the epoxy core label indicates that it contains U, it does not; the manufacturer inadvertently omitted the radioisotope. Two gypsum plaster core sections are available with known concentrations of U salt as well. As stated elsewhere, the epoxy and plaster cores’ activities are so low that they can be considered effectively non-radioactive for handling purposes.

In order to perform a KUT study, each detector must be calibrated against the standards, which in turn requires that the core section be centered over each detector. Do not try to use one epoxy or plaster core to cover more than one detector, although it is possible to position multiple standards over different detectors simultaneously.

1. Collect spectra for the standards, from each detector, for at least 30 minutes (preferably 2-4 hours) to acquire a high-quality spectrum. For good quantification, it is necessary to have individual radioisotope peaks on the order of 2000 counts (each).
2. Note that in order to position the standard core sections over detector #8, the rear door must be opened with the chain hoist and the plug at the end of the acrylic tube removed.
3.  $^{40}\text{K}$  decay produces only a single peak within the NGRL’s sensitivity range, and presuming  $^{238}\text{U}$  concentration is not high, evaluation of the  $^{40}\text{K}$  peak is relatively straightforward. High  $^{238}\text{U}$  concentration creates a “shoulder” peak on the  $^{40}\text{K}$  peak and must be deconvoluted from the potassium signal to produce the correct  $^{40}\text{K}$  concentration.
4.  $^{232}\text{Th}$  and  $^{238}\text{U}$  decay produces a large number of gamma-ray peaks, making quantification much more challenging. For reference, a decay isotope diagram for the Th and U chains are provided here (*Figures 33 and 34*).

It is beyond the scope of this manual to describe the full analytical procedure. Dunlea et al. (2013) provides some guidance on this matter.

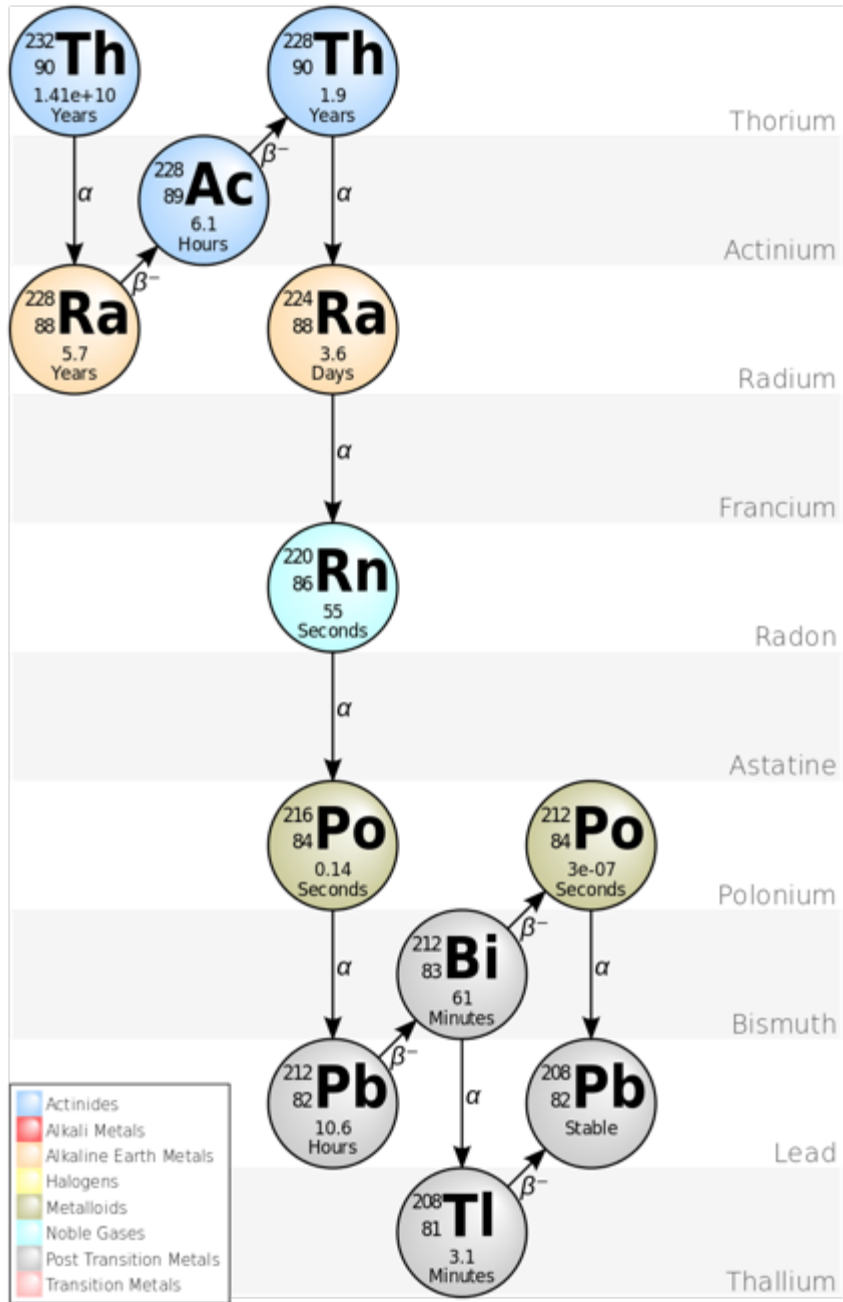

Figure 33. Thorium Decay Chain. By <http://commons.wikimedia.org/wiki/User:BatesIsBack> - [http://commons.wikimedia.org/wiki/File:Decay\\_Chain\\_of\\_Thorium.svg](http://commons.wikimedia.org/wiki/File:Decay_Chain_of_Thorium.svg), CC BY-SA 3.0, <https://commons.wikimedia.org/w/index.php?curid=16983885>

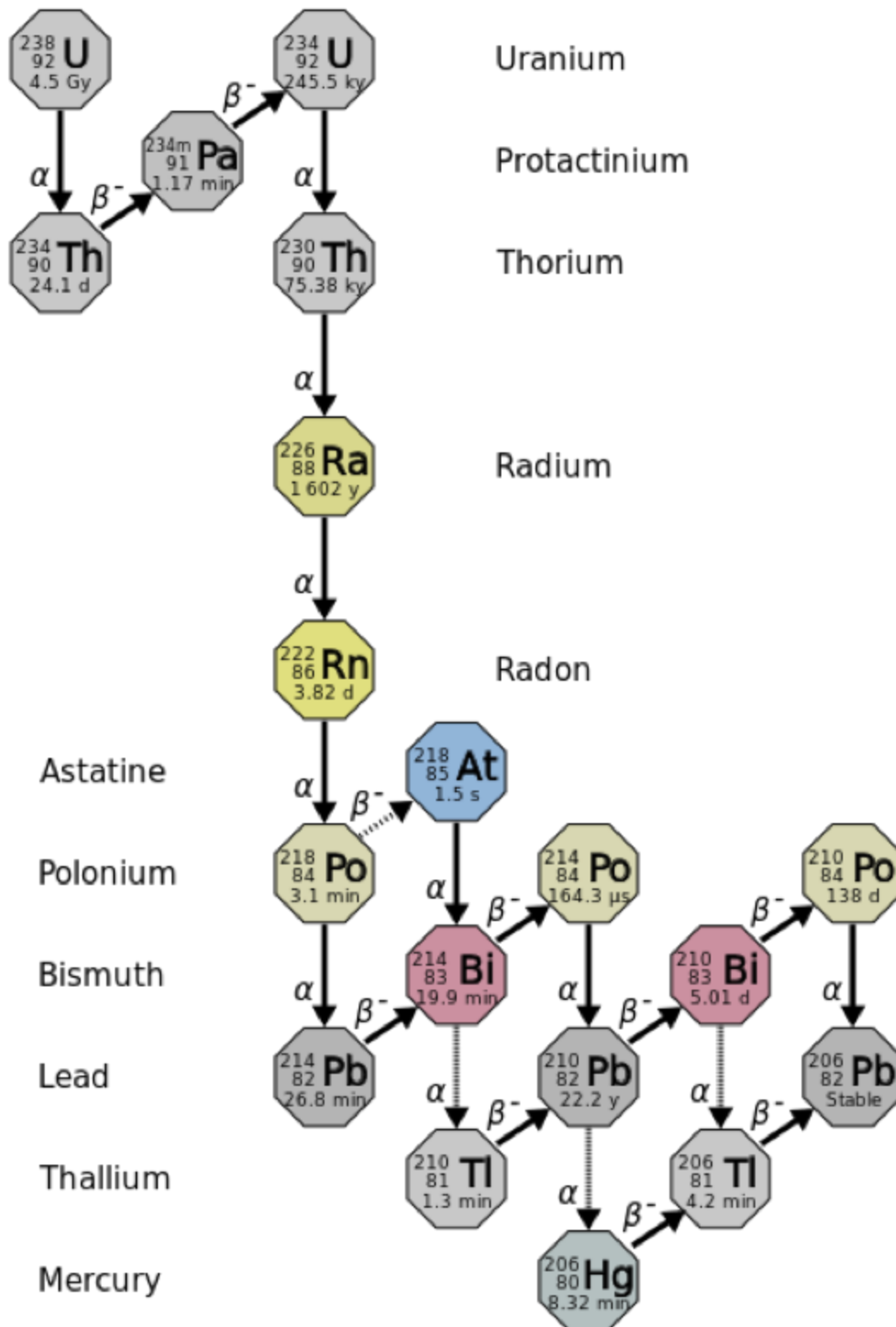

Figure 34. Uranium Decay Chain. By User: Tosaka - File:Decay chain(4n+2, Uranium series).PNG, CC BY 3.0, <https://commons.wikimedia.org/w/index.php?curid=33293646>

## Time Calibration

Time calibration refers to the process of ensuring that the fast signal from the NaI detectors and the fast signal from the plastic detectors occur close enough in time for the coincidence logic modules to work properly. In general terms, a radioactive source (the disk sources) is placed over the

detector and the acrylic tube is rotated off its normal position to move the lead spacers away from the plastic scintillators. Gamma and charged particle signals produced by the source are now at such a frequency that the logical coincidence signal is clear and the two detectors' fast outputs can be aligned to allow the proper anticoincidence VETO signal to be produced.

This procedure is beyond the scope of this manual.

## Sample Preparation and Analysis

This section gives instructions for running whole-core sections through the NGR system.

### Preparing Samples

It is very important that no water or mud enters the NGR, as the NaI detectors are hygroscopic and there is high voltage (~1 kV) applied to the scintillators and photomultipliers. Any mud or dust inside the system will stay there and become an additional source of radioactive background, which will negatively affect all following measurements. All core sections and boat surfaces **must be cleaned and wiped dry**. Additional preparations include:

- Equilibrate cores to room temperature
- Degas cores as much as possible to avoid "mud worms" in the bore of the NGR
- Use D-tube tape to cover holes

### Running Samples

1. Place the core section in the titanium boat on the NGR delivery system loading track. Ensure the blue end of the core section is against the leading edge of the boat (closest to the NGR door)  
 Note: the PMTs for the door plastic scintillators are visible (and exposed to potential damage) so significant care must be taken during core section movement to avoid the possibility of damaging the detector or PMTs.
2. Open IMS-NGR (Figure 9), which is usually found on the NGR's workstation desktop.
3. Press the **Start** button (Figure 10) on the NGR Core Analyzer screen to initiate a run. The **Section Information** dialog window will appear (Figure 35). Use the barcode scanner to scan the section's label. Its information will be retrieved from the database; however, the user must verify the physical length of the section (**User Length**) and enter it before measurement can begin.

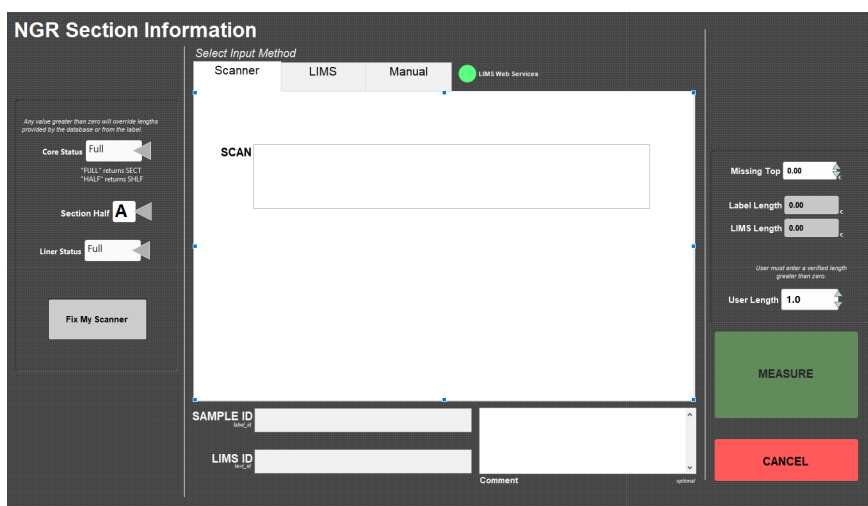

Figure 35. IMS-NGR Section Information window

4. Click **Measure** in the Sample Information window and the boat will begin moving. The boat will proceed automatically into the chamber without further intervention, so be sure the track is clear of obstructions.
5. As soon as the sample reaches measurement position 1, the measurement will begin. Eight channels will collect gamma ray counts from measurement points along the core section in Position #1 for a user-defined time period.
6. The core will move automatically outboard 10 cm into Position #2 and again collect data for another eight positions (for a total of 16 measurement positions every 10 cm for a 150 cm section).
7. As the sensors take measurements, counts are plotted vs. sensor number on the main screen. Hit the Detail/Summary button at the upper right of the screen to switch between the histogram vs. binned mode displays. The button name changes from Summary to Detail, depending on which view is selected (Figure 36 and 37).

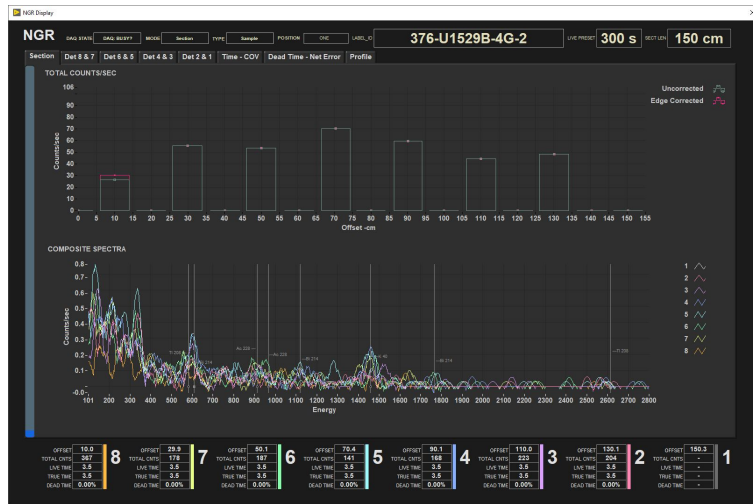

Figure 36. Core Analyzer Screen Showing Histogram.

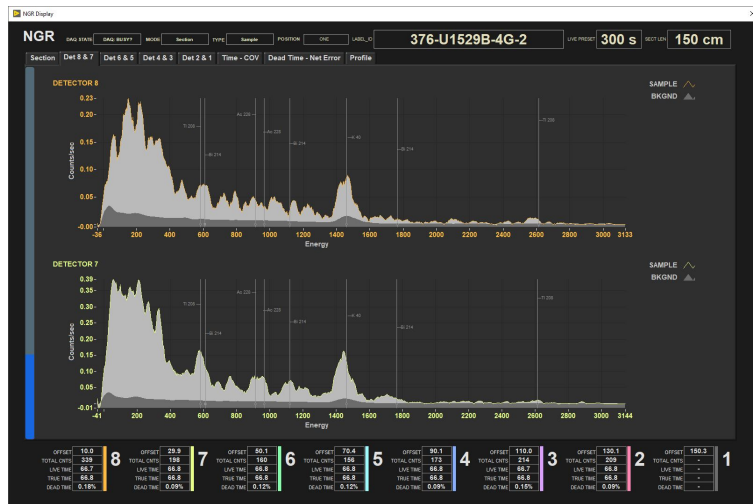

Figure 37. Core Analyzer Screen in Individual Detector Reading Display.

8. Elapsed time (on the left side of window) during normal run (e.g., with 10 min acquisition time per position should go up to 21–22 min).
9. After data acquisition finishes, the boat will retract from the NGR chamber automatically. It is therefore important not to have anything blocking the actuator's path.
10. The analysis is now complete.

## Running the NGR during High Recovery Cruises

During high-recovery cruises, the normal ~11-12 min. NGRL run may be too long to keep up with core flow. The 300 seconds-per-position measurement time is the minimum time needed for good statistical measurements, so reducing it is not recommended. Instead, the software can be instructed to only measure at position #1 or position #2, cutting overall measurement time in half. This will create an interleaved measured/not-measured 10-cm pattern in the data, but the actual data points will be of the normal NGRL data quality.

Again, reducing the NGRL run time below this single-position measurement is not recommended!

## LIMS Integration

### Data Upload Procedure

Data is automatically saved to the C:/Data/In folder on the computer. The MegaUploadatron application locates these files and uploads them to LIMS. Once the upload is completed the data is moved to C:/Data/Archive.

### Data File Formats

The files generated by the NGR system are:

- **i\_pi\_ngr927.ini**: A file containing the NGR configuration information for each detector at the time of measurement
- **.NGR**: A file containing the total counts per second, relative error, and absolute error for each detector. This is the load file uploaded to the database.
- **.csv**: A summary .csv file containing the raw measurement data for each detector for a section of core
- **.zip**: A zip file containing:
  - The spectral files (.SPE) for the background measurement, the calibration, and for each detector at each measurement position. These files contain the energy voltage value at each channel.
  - The configuration .ini
  - The .csv file
  - An edge correction file

## Data Available in LORE

The NGR data is available in LORE under Natural Gamma Radiation (NGR). The expanded report includes the linked data files.

- **Exp**: expedition number
- **Site**: site number
- **Hole**: hole number
- **Core**: core number
- **Type**: type indicates the coring tool used to recover the core (typical types are F, H, R, X).
- **Sect**: section number
- **A/W**: archive (A) or working (W) section half.
- **Offset (cm)**: position of the observation made, measured relative to the top of a section.
- **Depth CSF-A (m)**: location of the observation expressed relative to the top of a hole.
- **Depth [other] (m)**: location of the observation expressed relative to the top of a hole. The location is presented in a scale selected by the science party or the report user.
- **NGR total counts (cps)**: rate of natural gamma radiation across the entire spectrum of ~0.1-3 MeV.
- **Error (cps)**: absolute error of measurement; 1 divided by the square root of the total counts (s) divided by the number of seconds.
- **Relative Error**: relative error of measurement; Error (cps) / NGR total counts (cps).
- **Timestamp (UTC)**: point in time at which the observation was made on the logger.
- **Instrument**: an abbreviation or mnemonic for the sensing device used to make this observation.
- **Instrument group**: abbreviation or mnemonic for the data collection device (logger) used to acquire this observation (NGR).
- **Text ID**: automatically generated unique database identifier for a sample, visible on printed labels.
- **Test No**: Unique number associated with the instrument measurement steps that produced these data.
- **Comments**: observer's notes about a measurement, the sample, or the measurement process.

## Communication and Control Setup

Data communication and control is USB based and managed via National Instrument's Measurement & Automation Explorer (NI-MAX). When you open NI-MAX and expand the Device and Interface section. The correct communications setup can be found at [IMS Hardware Communications Setup](#).

## Credits

This document originated from the web page "NGR User Guide (IMS-378P)" by Ty Cobb (see Archived Versions below for a pdf copy). Credits for subsequent changes to this document are given in the page history.

## Archived Versions

- [NGR User Guide 2020 \(\\*.pdf\)](#)
- [NGR-IMS User Guide draft.pdf](#)